

Errata

Title & Document Type: 10529A Logic Comparator Operating and Service Manual

Manual Part Number: 10529-90005

Revision Date: January 1971

About this Manual

We've added this manual to the Agilent website in an effort to help you support your product. This manual provides the best information we could find. It may be incomplete or contain dated information, and the scan quality may not be ideal. If we find a better copy in the future, we will add it to the Agilent website.

HP References in this Manual

This manual may contain references to HP or Hewlett-Packard. Please note that Hewlett-Packard's former test and measurement, life sciences, and chemical analysis businesses are now part of Agilent Technologies. The HP XXXX referred to in this document is now the Agilent XXXX. For example, model number HP8648A is now model number Agilent 8648A. We have made no changes to this manual copy.

Support for Your Product

Agilent no longer sells or supports this product. You will find any other available product information on the Agilent Test & Measurement website:

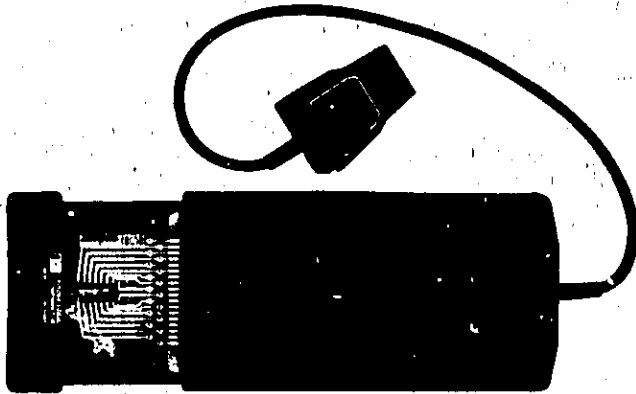
www.agilent.com

Search for the model number of this product, and the resulting product page will guide you to any available information. Our service centers may be able to perform calibration if no repair parts are needed, but no other support from Agilent is available.

OPERATING AND SERVICE MANUAL

LOGIC COMPARATOR

10529A



HEWLETT  PACKARD

CERTIFICATION

The Hewlett-Packard Company certifies that this instrument was thoroughly tested and inspected and found to meet its published specifications when it was shipped from the factory. The Hewlett-Packard Company further certifies that its calibration measurements are traceable to the U.S. National Bureau of Standards to the extent allowed by the Bureau's calibration facility.

WARRANTY AND ASSISTANCE

This Hewlett-Packard product is warranted against defects in materials and workmanship. This warranty applies for one year from the date of delivery, or, in the case of certain major components listed in the manual, for the specified period. We will repair or replace products which prove to be defective during the warranty period provided they are returned to Hewlett-Packard. No other warranty is expressed or implied. We are not liable for consequential damages.

Service contracts or customer assistance agreements are available for Hewlett-Packard products that require maintenance and repair on-site.

For any assistance, contact your nearest Hewlett-Packard Sales and Service Office.

LOGIC COMPARATOR 10529A

SERIAL PREFIX: 1240A

This manual applies directly to standard Hewlett-Packard Model 10529A Logic Comparators with serial prefix 1240A.

SPECIAL INSTRUMENTS AND SERIAL PREFIXES NOT LISTED:

The information required to relate this manual to special modifications, or to newer instruments with serial prefixes not listed, is supplied on special insert sheets. If this information is missing, contact any Hewlett-Packard Sales and Service Office, giving full specification number, instrument name, and serial number.

Copyright HEWLETT-PACKARD COMPANY 1971
5301 STEVENS CREEK BLVD., SANTA CLARA, CALIF. 95050

Printed: AUG 1973

Manual Part No. 10529-90005

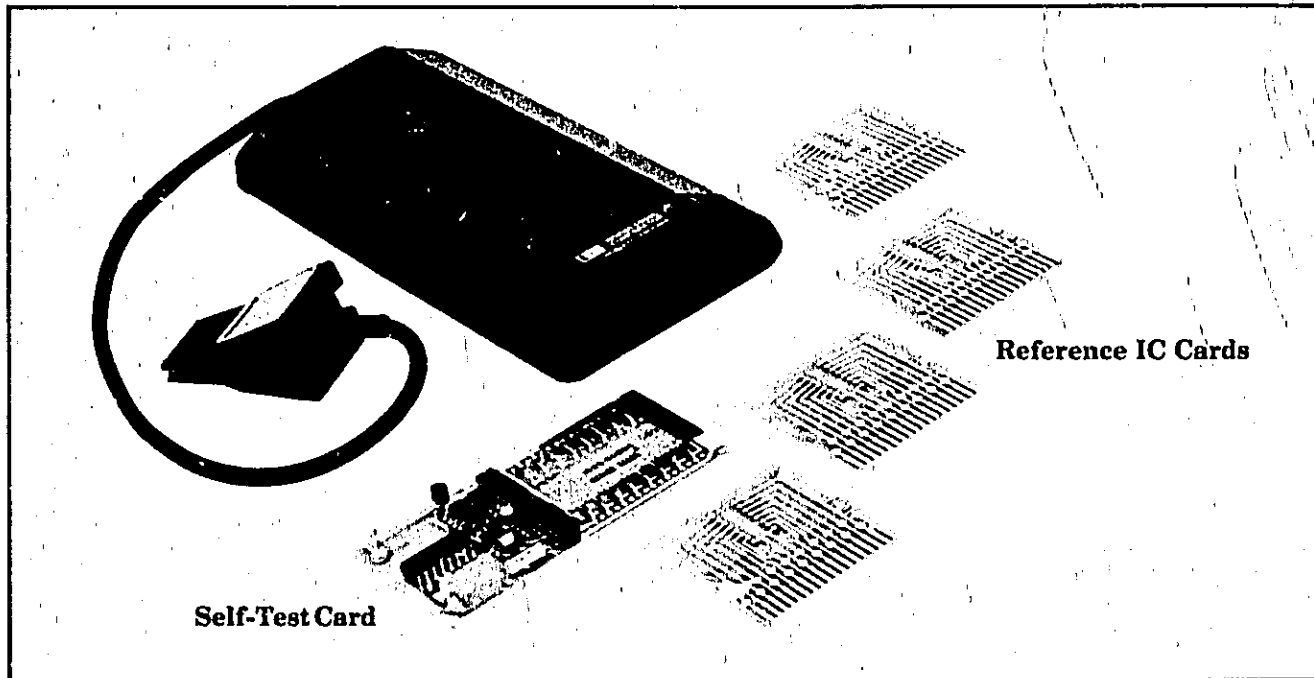
PRINTED IN U.S.A.

HEWLETT  PACKARD

TABLE OF CONTENTS

Section		Page
I	GENERAL INFORMATION	1
II	INSTALLATION	4
III	OPERATION	8
IV	THEORY OF OPERATION	15
V	MAINTENANCE	21
VI	REPLACEABLE PARTS	31
VII	OPTIONS AND MANUAL CHANGES	39
VIII	CIRCUIT DIAGRAMS	40

Figure 1-1. 10529A Logic Comparator



SECTION I GENERAL INFORMATION

1-1. DESCRIPTION

1-2. The 10529A Logic Comparator (Figure 1-1) will test the performance of an operating integrated circuit (IC) by comparing it to a reference (known to be good) IC of the same type.

1-3. Seventeen light-emitting diodes (LED's) are the indicators on the comparator. One LED indicates "power on". The other sixteen LED's, arranged in two rows of eight, indicate the comparison of the logic states between a reference IC and an IC under test. The logic state at each IC connecting pin is shown by an LED that matches the position of the IC pin. A lighted LED indicates opposite logic states for that output pin of the reference IC and the in-circuit IC. Therefore a lighted LED indicates a defect.

1-4. INSTRUMENT IDENTIFICATION

1-5. Each Hewlett-Packard instrument has a ten-character serial number (e.g., 1234A56789). The four-digit serial number prefix identifies a group of identical instruments, and the five-digit suffix is a serial number unique to each instrument. If the serial prefix on your instrument is not on the title page of this manual, your instrument is different from this manual. A supplement included with the manual describes the differences. If the supplement is missing, request one from the nearest Hewlett-Packard Sales and Service Office listed at the back of this manual.

1-6. EQUIPMENT SUPPLIED AND AVAILABLE ACCESSORIES

1-7. The logic comparator is supplied with:

Self Test Card 10529-60004* (one)

Reference IC Card (empty) 10529-20005* (ten)

Accessories available:

- 10528A* HP Logic Clip (complementary instrument)
- 10525T* HP Logic Probe (complementary instrument)
- 10526T* HP Logic Pulser (complementary instrument)
- 10529A (Option 001): 10541A* Reference IC Card Kit (includes 20 reference IC cards in storage case)
- 10529A (Option 002): K01-10541A* (20 preprogrammed reference boards). *Contact local HP Sales Office for current data on above.*
- 10529A (Option 003): External Reference Kit
- 60063B* HP Power Supply (must be adjusted to 5 volts dc for self-test card).

**Hewlett-Packard model or part numbers*

1-8. APPLICATIONS

1-9. The logic comparator is useful for quick troubleshooting in equipment with digital integrated circuits,

especially for troubles in a long chain of integrated circuits. The comparator is a useful production, service and design-troubleshooting tool. This unit clips onto powered TTL or DTL IC's and instantly displays any logic state differences between the test IC and a reference IC. Logic differences are identified to the specific pin(s) on 14 or 16 pin dual in-line packages with the comparator's display of 16 light emitting diodes. A lighted diode corresponds to a logic difference. The logic comparator can save time in locating a faulty IC. It requires no knowledge of the circuit operation under test. There are no controls to be set, and it needs no power connections. A suspected IC is located. A reference card loaded with good IC of the same type is then inserted in the comparator. The comparator is clipped onto the suspected IC, and an immediate indication is given as to whether the suspected IC is good or bad.

1-10. SPECIFICATIONS

1-11. Specifications for the Hewlett-Packard Model 10529A Logic Comparator are given in Table 1-1.

Table 1-1. Specifications

Input Threshold: 1.4 volts nominal, TTL or DTL compatible.

Input Impedance: "Test IC" inputs loaded by three low-power TTL loads (360 microamperes typical) plus input of "Reference IC." "Test IC" outputs loaded by two low-power TTL loads.

Input Protection: Voltages $<-1V$ or $>7V$ must be current limited to 10 milliamperes or damage will result.

Supply Voltage: 5 volts $\pm 10\%$

Supply Protection: Supply voltage must be limited to 7 volts.

Maximum Current Required:
300 milliamperes

Sensitivity:

Error Sensitivity: 200 nanoseconds. Errors greater than this are detected and stretched to at least 0.1 second.

Delay Variation Immunity: 50 nanoseconds. Errors shorter than this value are considered spurious and ignored.

Temperature: 0° to 55° Centigrade

Dimensions: 1.4 inches deep, 3.375 inches wide, 7.15 inches long (3.56 × 8.55 × 18.2 cm).

Weight: Net, 2 lbs. 6 oz. (1.14 kg). Shipping, 2 lbs. 6 oz. (1.62 kg).

Accessories Included:

1 test board
10 blank reference boards
1 carrying case
1 1/8" twist drill (with knob)

SECTION II INSTALLATION

2-1. INTRODUCTION

2-2. This section explains how to set up the logic comparator. Instructions for unpacking, inspecting, preparing, and testing the comparator are included. Read the entire section before starting to use the comparator.

2-3. ENVIRONMENT

2-4. Permissible environmental ambient conditions are given in the specifications table of Section I.

2-5. UNPACKING AND INSPECTING FOR DAMAGE

2-6. If the comparator shipping carton is damaged, inspect the comparator for visible damage (scratches, dents, etc.). If the comparator is damaged, notify the

nearest Hewlett-Packard sales and service office immediately. (Offices are listed at the end of this manual.) Keep the shipping carton and packing material for the carrier's inspection. The HP Sales and Service Office will arrange for repair or replacement of your instrument without waiting for the claim against the carrier to be settled.

2-7. REPACKING FOR SHIPMENT

2-8. If it is necessary to reship a comparator, good commercial packing methods and materials should be used.

NOTE

Before returning a comparator to Hewlett-Packard, contact the nearest Hewlett-Packard Sales and Service office for instructions.

2-9. POWER REQUIREMENTS

2-10. All operating power for the logic comparator is drawn from the circuit being tested through the IC clip. No batteries or line power is used. The reference IC card has solderable connections to provide operating power to the comparator from the circuit being tested. Integrated circuits in the logic comparator are low-power TTL units to keep power consumption low.

2-11. REFERENCE IC (INTEGRATED CIRCUIT) MOUNTING

2-12. Before the comparator is used to test an IC in operating equipment, one reference IC must be installed on a 10529-20005 reference IC card. The reference IC must be the same type as the IC to be tested, and it must be good. (See Figure 2-1.) Ten reference cards are supplied with a new comparator. Extra cards are available from Hewlett-Packard. Contact your nearest Hewlett-Packard Sales and Service Office for price and delivery of blank reference IC cards.

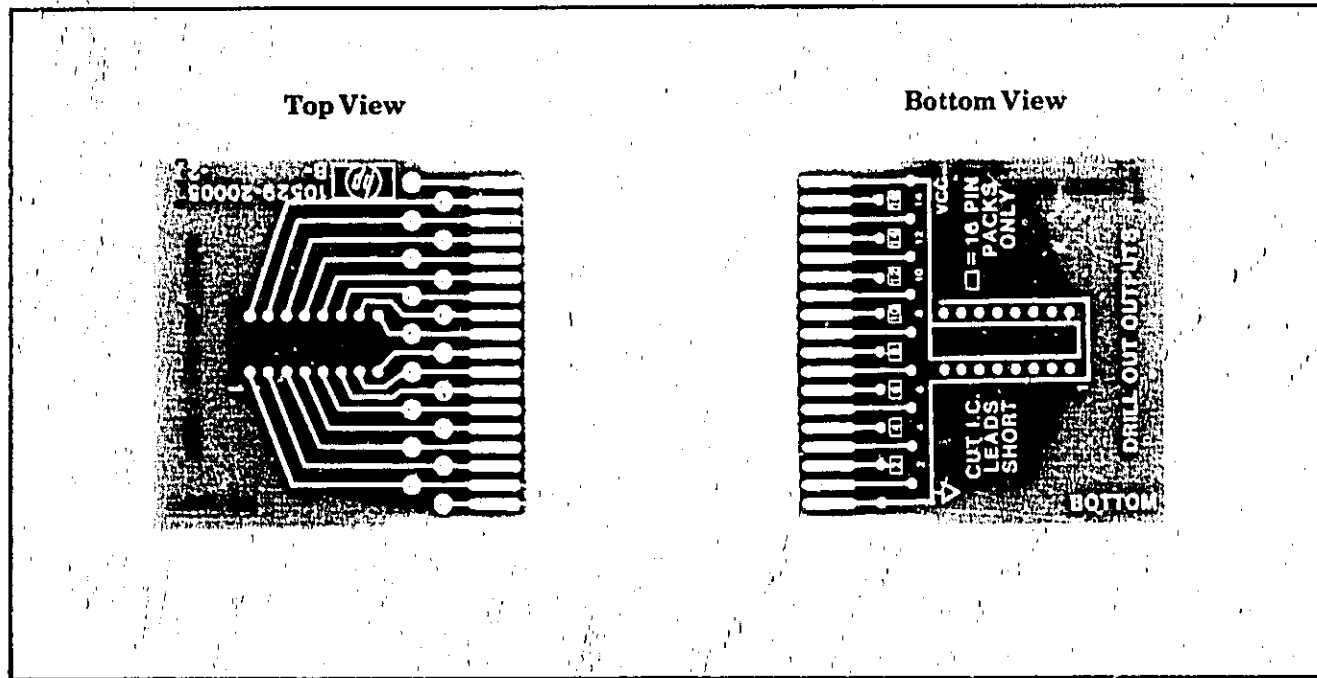
2-13. Check the location of pin 1 on the reference IC and match it to the pin "1" on the reference IC card. Put the reference IC pins into the correct holes of the card. Note the metal pattern on the "BOTTOM" of the reference IC card. The line marked COM (GND) will be connected to the common (ground) pin of the reference IC, and the line marked Vcc will be connected to the Vcc pin of the reference IC.

a. At the bottom of the IC reference card, bend the reference IC common ("ground") pin over on the card COM ("GND") line and solder the pin and line together.

b. Bend the reference IC "Vcc" pin over on the card "Vcc" line and solder the pin and line together.

c. Solder the remaining reference IC pins in the respective holes. Do NOT short any pins together, and do NOT short any pins to the COM (GND) or Vcc line except the correct pins.

Figure 2-1. Reference IC Card, Top and Bottom



NOTE

The holes on the reference IC card next to the card connector (P1) pins have metal foil connecting through the card to the P1 pins on the other side.

d. Identify the output pins on the reference IC. Disconnect the reference IC outputs between the top and bottom of the reference card P1 pins. Use $\frac{1}{8}$ " twist-drill (supplied) as a countersink to remove

the small pad around the plated-through holes. **DO NOT DRILL COMPLETELY THROUGH BOARD.** (This procedure breaks the plated through electrical connection and sends the outputs of the reference IC and the IC under test to separate inputs of the same exclusive OR gate.) Use an ohmmeter to be sure the correct pins on the top and bottom have been disconnected.

e. The reference IC card is ready for use in the comparator.

OPERATION

SECTION III OPERATION

3-1. INTRODUCTION

3-2. This section tells how to use and operate the 10529A Logic Comparator.

NOTE

Do not exceed 7V maximum.

3-3. OPERATING MODES

3-4. Four modes of operation are possible with the logic comparator:

- a. IC logic comparison test
- b. Electronic self-test
- c. Cable continuity self-test
- d. External reference.

3-5. IC Logic Comparison Testing

3-6. In this mode an operating in-circuit IC is output-compared to a good reference IC of the same type mounted on a printed circuit card installed in the comparator.

3-7. Electronic Self-Test

3-8. In this mode the comparator self-test card with +5 Vdc power connected is installed in the comparator, and the LED display is observed for indications of comparator condition. All of the LED's will blink on and off about once every two seconds if the comparator is working properly. If any or all LED's do not blink, something is wrong. Refer to Paragraph 5-9.

3-9. Cable Continuity Self-Test

3-10. In this mode the LED display indicates electrical continuity of the IC test clip and its cable. The comparator self-test card with +5 dc power connected is installed in the comparator, and the IC test clip is attached to the dummy IC on the self test card. All LED's should blink on for alternately long and short periods. If one or more LED's blink the same as in test mode one, this indicates an open circuit somewhere from that IC clip pin to the corresponding logic channel on the main board or LED board. Refer to Paragraph 5-9.

3-11. OPERATING CONTROLS

3-12. There are no operating controls in the comparator.

3-13. OPERATOR CONTROLLED ASSEMBLIES

3-14. The comparator has the following four operator controlled assemblies.

- a. Reference IC card (See Figure 3-1.)
- b. Reference IC drawer (See Figure 3-2.)
- c. IC test clip (See Figure 3-2.)
- d. Comparator self-test card (See Figure 3-1.)

3-15. Reference IC Cards

3-16. One of the ten reference IC cards, included with each logic comparator is installed in the reference IC drawer of the comparator (see Figure 3-3), and the drawer is closed. See Section II for reference IC installation.

3-17. Reference IC Drawer

3-18. The reference IC drawer holds either a reference IC on a card or the comparator test card. When you open the drawer be careful not to drop the reference IC card.

Figure 3-1. Operator Controlled Assemblies

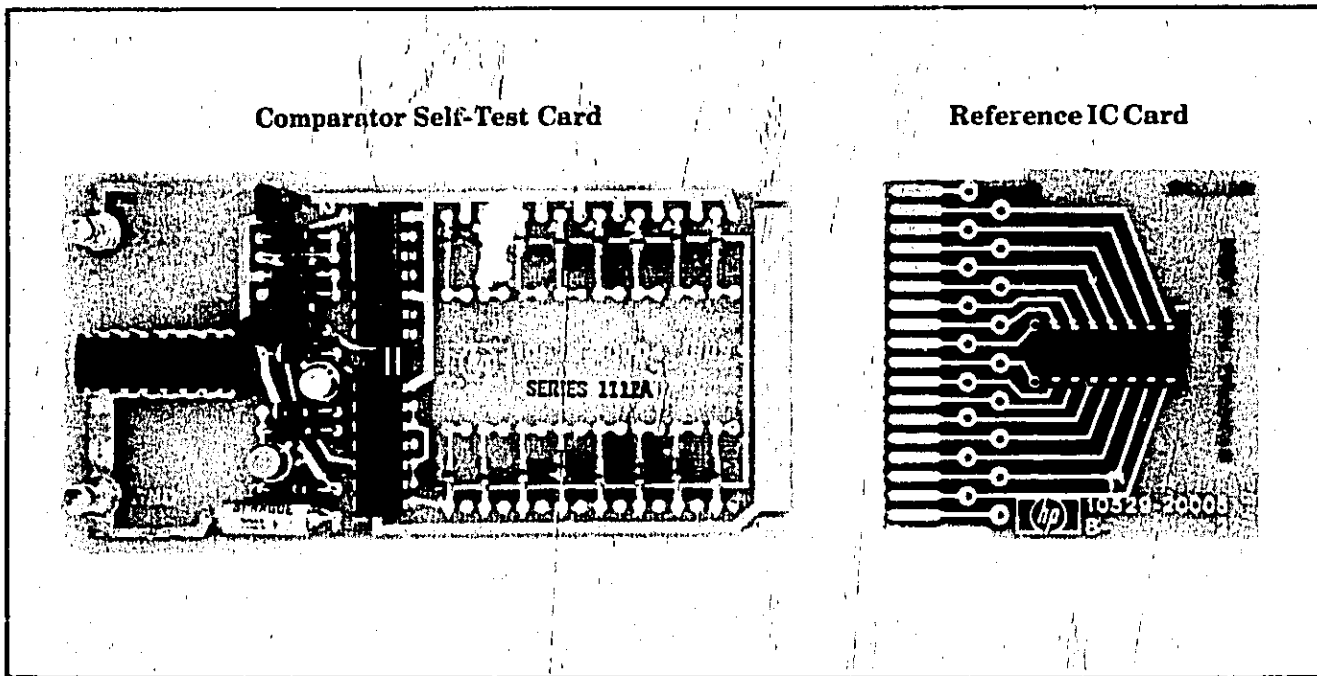


Figure 3-2. Reference IC Drawer and IC Test Clip

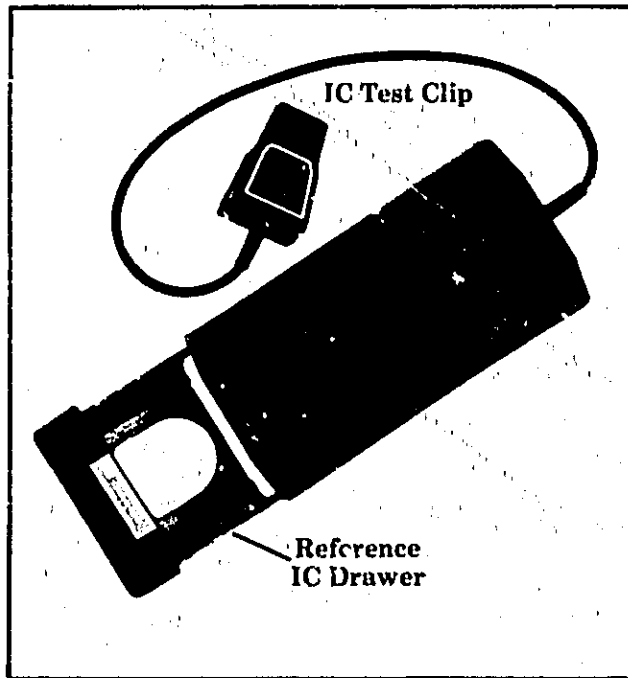
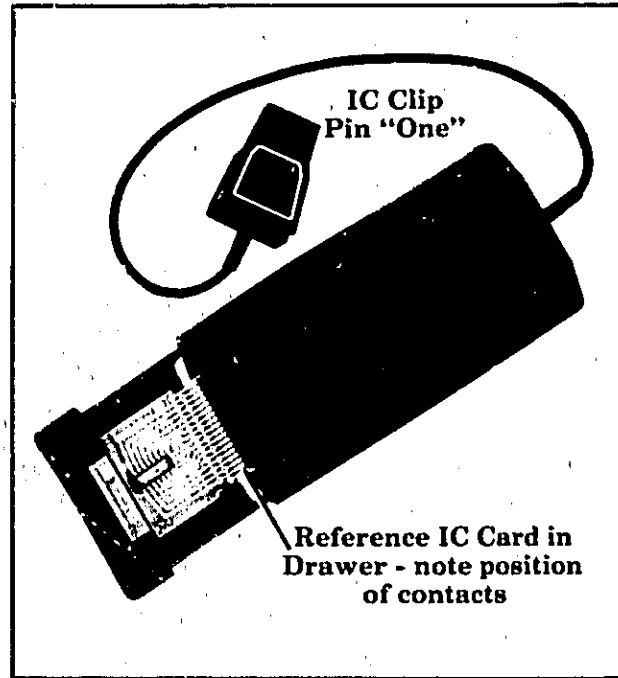


Figure 3-3. Reference IC Card in Comparator Drawer



3-19. IC Test Clip

3-20. The IC test clip clamps on the in-circuit IC to be tested. Be sure "1" on the clip matches pin one of the IC.

3-21. Comparator Self-Test Card

3-22. The comparator self-test card is installed in the reference IC drawer to test the operation of the comparator. See Section V for use of this card.

3-23. IC COMPARISON TEST INSTRUCTIONS

3-24. This is how to use the logic comparator:

a. Pull the drawer out of the comparator case, and put the correct reference IC card in the opening (see Figure 3-3 for correct position of IC card). Push the drawer back in the case.

b. Put the IC connector clip on the IC to be tested. Be sure to position the IC connector clip pin \odot index mark with pin one of the IC to be tested. (See Figure 3-3.)

c. The comparator middle ("ON") LED will light if the Vcc and "ground" connections are correct on reference IC, and the IC clip is clamped correctly on the IC to be tested.

d. If any of the sixteen LED's lights, the logic levels at that pin of the reference IC and the IC being tested are different. If a logic output of a reference and in-circuit IC are different it indicates one of the two IC's may be defective.

3-25. OPERATING NOTES

3-26. The following paragraphs give important operating notes.

NOTE

The comparator tests only the output nodes—see following paragraphs.

3-27. Reset Before Testing

3-28. The operation of a flip flop or other sequential device depends upon the previous input to that device, and since the reference device will not in general have had the same set of inputs as the device being tested, it is necessary to "reset" the devices before comparing. This can be done by first clipping the Comparator to the device to be tested and causing a reset signal to be supplied by either the circuit to be tested or the 10526T Logic Pulser. The Pulser can be used to inject a reset pulse into the IC's reset input. This then ensures that both devices start in the same state and will react the same to the sequence of input signals they receive. The Comparator will now flip and not flop when the flip-flop flips. If the test IC is good, the output states of the reference and test IC will always agree and the Comparator will not indicate a fault.

3-29. With memories and shift registers, the problem is quite similar as stated above. But instead of supplying a reset pulse to the circuit to bring them to a

known state, the Comparator must merely be attached to the test IC long enough for the reference IC to be loaded with the same data as the test IC. This should require no longer than 1 complete cycle of the memory or shift register. During the time the reference IC is being loaded with the data, the Comparator will give fault indications. If after a few cycle times the fault is still indicated, a fault has indeed occurred at the node indicated.

3-30. Non-TTL Rise Time and Levels

3-31. If the comparator is used to check a circuit that has a pulse waveform with a relatively slow rise-time, the two IC's (reference and circuit being tested) may trigger at different times and give a false LED "on" indication. Slight differences in rise time between two IC's of the same type are normal and must be considered when slow waveforms occur in the circuit being tested. Some TTL/DTL circuits are designed to have their inputs and/or outputs operating at other than standard TTL levels. Testing these circuits with the Logic Comparator may result in error indications from a properly operating circuit.

3-32. Circuit Output Loading

3-33. Normal operation of the comparator has the inputs of the in-circuit and reference IC's in parallel and their outputs are separated. If the in-circuit IC output is shorted (possibly by the next circuit), the comparator LED would indicate a defect. Such a defect can be in the IC under test or a following circuit.

3-34. Wired "OR" Logic Testing

3-35. Check the logic diagram of the equipment being tested with the logic comparator. Some IC logic circuits may defeat the logic comparator fault detection because of interconnection of logic elements. For example, a "wired OR" connection if tested by the logic comparator may have its output pulled low by an associated wired gate while the reference IC output in the logic comparator will follow the input logic levels.

THEORY

SECTION IV THEORY OF OPERATION

4-1. INTRODUCTION

4-2. This section describes the theory of operation of the logic comparator. Circuit logic and timing are described.

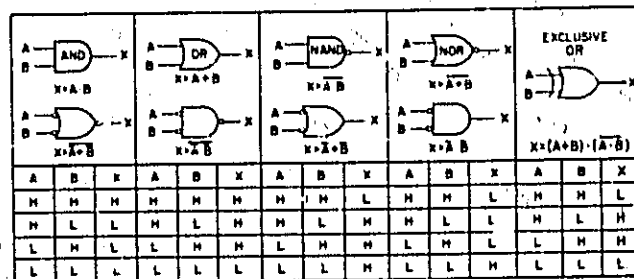
4-3. ELECTRONIC LOGIC

4-4. The logic comparator uses the binary system of electronic logic. In a binary system two states can exist, and any two symbols can represent the states. Commonly used symbols are: 1 and 0, and HIGH and LOW (abbreviated H and L) for the two states.

4-5. LOGIC CIRCUIT ELEMENTS

4-6. Electronic logic circuits use a few basic elements: gates, flip-flops, and inverters. Figure 4-1 shows symbols and condition tables for the gate elements.

Figure 4-1. Gate Symbols and Logic Comparisons



4-7. AND and OR GATES. The AND gate output is high if all inputs are high. AND gates may have two or more input lines.

4-8. The OR gate output is high if one or more inputs are high. An OR gate may also have two or more inputs.

4-9. **NAND and NOR GATES (INVERSION).** A circle at a logic symbol indicates inversion or NOT function. A circle at the output of an AND gate indicates a low output when the gate is activated. (The output is low if all inputs are high.) This is a NOT-AND gate or NAND gate.

4-10. A circle at the output of an OR gate indicates the output is low if the gate is activated. (The output is low if any or all inputs are high. The output is high only if all inputs are low.) This is a NOT-OR gate or NOR gate.

4-11. **EXCLUSIVE OR GATE.** The two-input EXCLUSIVE OR gate output will be high (gate activated) if the inputs are different (H-L or L-H).

4-12. The output will be low if the inputs are the same (H-H or L-L).

4-13. **GATE EQUALITY.** Each gate form has a functional equivalent except the exclusive OR and NOR gates. Figure 4-1 shows each pair of identical function gate symbols together with the condition tables

and Boolean formulas. For example: a two-input AND gate is functionally equal to a NOR gate with inverted inputs.

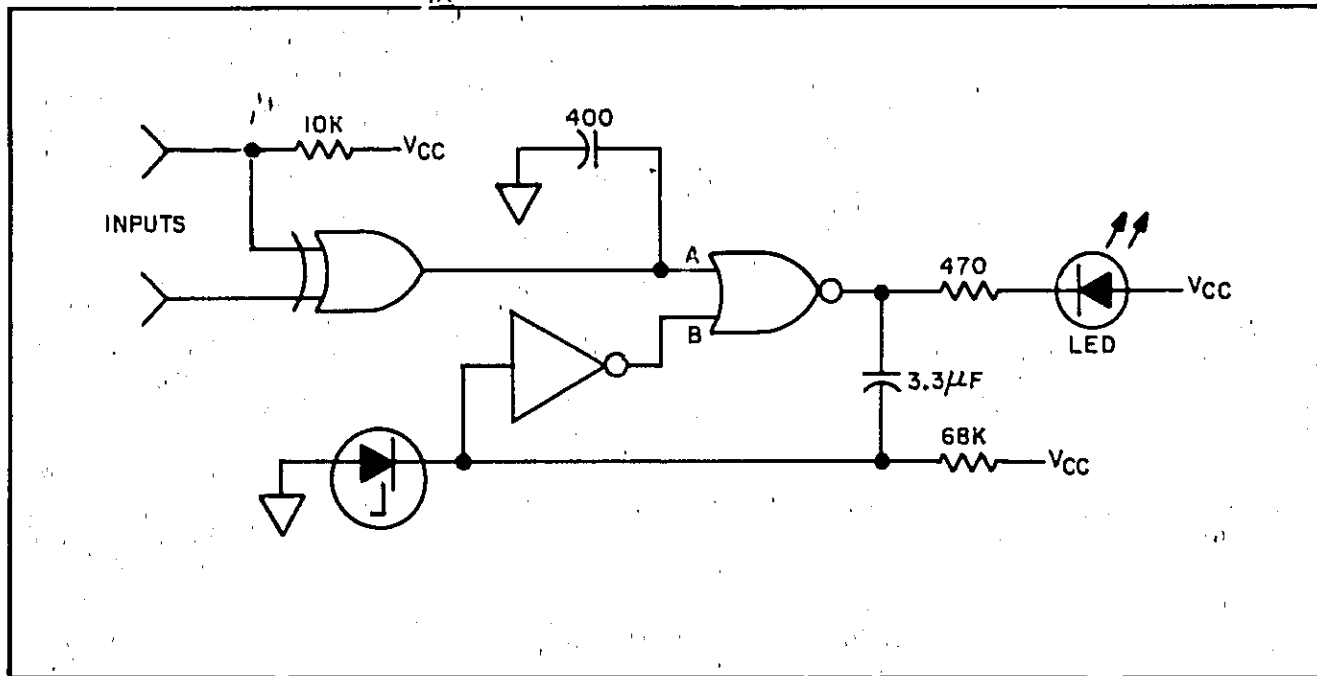
4-14. COMPARATOR LOGIC

4-15. The 16 LED indicators are the output elements in 16 identical logic channels. Each channel is separate from the other 15 unless they are connected externally or at the reference IC card. Following is a description of one logic channel that applies to all.

4-16. LOGIC CHANNEL

4-17. Figure 4-2 is a schematic diagram of one logic channel in the comparator. In operation, the two separate inputs (A and B) of the exclusive OR gate are connected separately to outputs of the circuit under test and the test reference circuit, respectively. Since the circuit under test and the test reference circuit have their inputs in parallel, their outputs should be identical. Sequential logic circuits must be reset to the same state. If at any time the circuit under test and the test reference circuit outputs are different, the

Figure 4-2. One Comparator Logic Channel Schematic



exclusive OR gate output will change to a logic high. This high connects to the A input of the NOR gate and switches the NOR gate output low which activates the LED.

4-18. The capacitor at the NOR gate output and the inverter between the capacitor and the NOR gate B input comprise a pulse stretcher to keep the LED "on" long enough to be visible. The capacitor at the output of the exclusive OR gate slows the action of the comparator so minor differences in the speed of circuit under test and the test reference circuit IC's will not cause a false LED indication.

4-19. COMPARATOR SELF TEST CARD

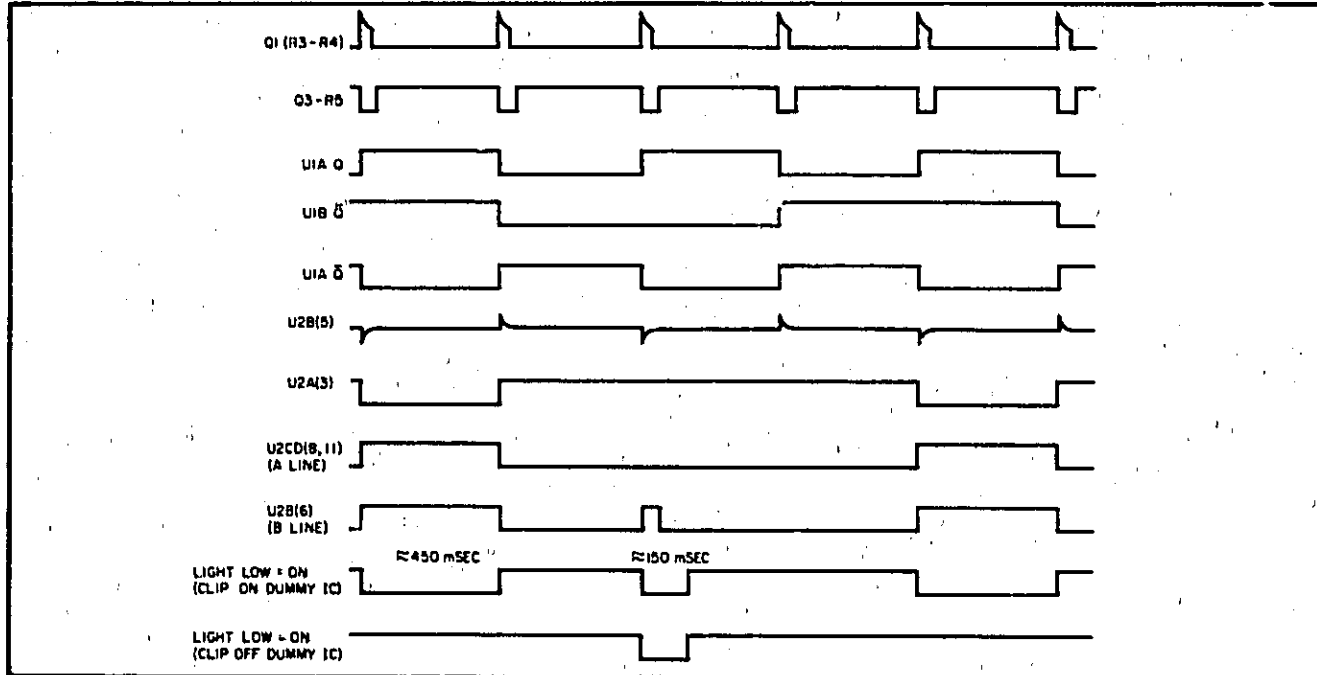
4-20. Figure 8-7 is a schematic of the logic comparator self test card. With the test card, operation of the comparator LED's can be checked. Timing relationships of the test card signals are shown in Figure 4-2. The test card produces a two Hertz (approximate) positive pulse from a unijunction transistor relaxation oscillator, Q1. The positive pulse is amplified and inverted

by Q3, and it is used to clock the J-K flip-flop U1 (C1 input). The U1A flip-flop square wave output (pin 12) is the (pin 1) input of NAND gate U2A and the clock (pin 5) input for U1B, the second J-K flip-flop. The U1B (pin 9) output square wave is half the frequency of the U1A signal. The output of NAND gate U2A(3) is low while U1AQ and U1BQ are high. The square wave output of U2A is inverted by U2D and U2C, and the square wave output of U2D and C is applied to the A line.

4-21. The Q (pin 13) output square wave of flip-flop U1A is differentiated by C2 which makes alternate positive and negative sharp pulses at the U2B pin 5 input. Only the negative pulses cause a short pulse at the output of U2B. The other input of U2B receives the same square wave as U2D and C. The output of U2B (or B line) is the same as U2D and C with the short pulse added. See Figure 4-3.

4-22. As shown in Figure 4-3, the U2D and C output or A line has a square wave with the positive part about 1/3 the duration of the negative part. (The period of this square wave is approximately two seconds.)

Figure 4-3. Test Card Timing Diagram



The B line has the same square wave as the A line, with another very short positive pulse. (The short positive pulse on the B line is very difficult to see with an oscilloscope, but the Hewlett-Packard 10525T logic probe, with its stretching circuit, will display the short pulse.)

4-23. TEST MODES WITH SELF TEST CARD

4-24. Two modes of testing are possible with the self test card. The modes are selected by the position of the comparator IC clip. With the IC clip free or

not connected to anything, mode one is selected. Test mode two is selected with the IC clip connected to the self test card dummy IC, see Figure 5-5. In test mode one the self test card A and B line signals are connected to the A and B inputs of each of the 16 logic channels of the comparator. The logic channel output LED's only respond to differences between the two inputs. So in test mode one the LED's blink when the short B line pulse occurs. In test mode two the A line signal is shorted to common and the logic channel LED's blink on alternately long and short when the B line waveform is positive.

MAINTENANCE

SECTION V MAINTENANCE

5-1. INTRODUCTION

5-2. This section gives tests and procedures for maintenance of the comparator. The comparator assembly identification system is described, and all assemblies are listed. Procedures are given for disassembly, cleaning, inspection, test, and repair. A recommended test equipment list is given.

5-3. ASSEMBLY DESIGNATIONS AND LOCATIONS

5-4. Table 5-1 lists reference designations, name, and Hewlett-Packard part number of assemblies used in the comparator. Locations of the assemblies are shown in photographs of Section VIII.

5-5. DISASSEMBLY

5-6. Disassembly instructions for the comparator are given in the following steps:

a. At the cable end of the case, use a hex key to remove the two screws holding the end plate to the case (see Figure 5-1).

b. Pull the end plate and circuit boards about one inch out of the case, and use a Pozidriv screwdriver to remove the two screws that fasten the end plate to the main circuit board. (See Figure 5-2.)

Table 5-1. Assembly Designations

Reference Designation	Description	HP Part No.
A1	Display Board	10529-60003
A2	Main Board	10529-60002
A3	Self Test Card	10529-60004
W1	Test Cable	10529-60001

Figure 5-1. Removing End Plate Screws

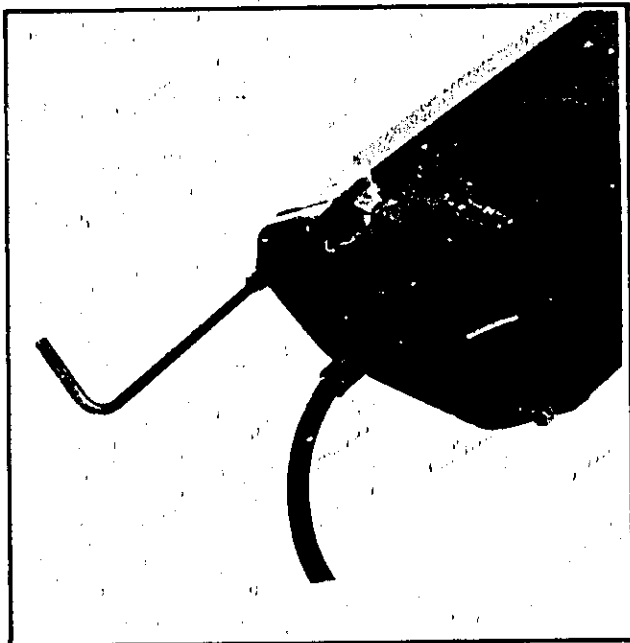
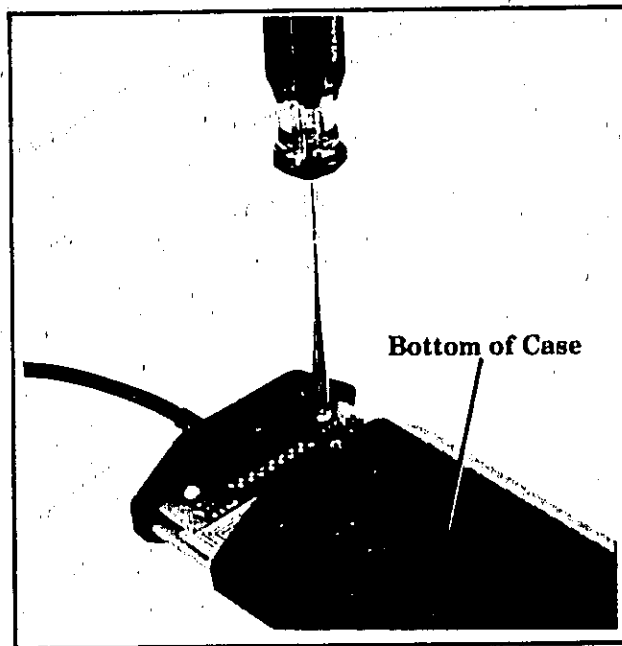


Figure 5-2. Removing Circuit Board Screws



c. Slide the end plate down the cable about six inches, and push the circuit boards out the drawer end of the case far enough to remove the drawer. (See Figure 5-3.) The tabs on drawer arms hold drawer in case.

d. Push the circuit boards back through the case and out.

e. Lift the LED mask off of the display board.

5-7. REASSEMBLY

5-8. Reassembly instructions for the comparator are given in the following steps:

a. Plug LED display board A1 (with LED mask in place) into the connector on the main board.

b. At the end of the case with screw threads in the bottom track slide the main board into bottom track with the display board sliding into the upper track.

c. Push the boards partly through the case so the drawer-arms tabs fit over the wide connector on the main board. (See Figure 5-3.) Put drawer side ridges into case groove.

d. Push the drawer and boards back into case and pull the main board out the end of the case slightly. (See Figure 5-2.)

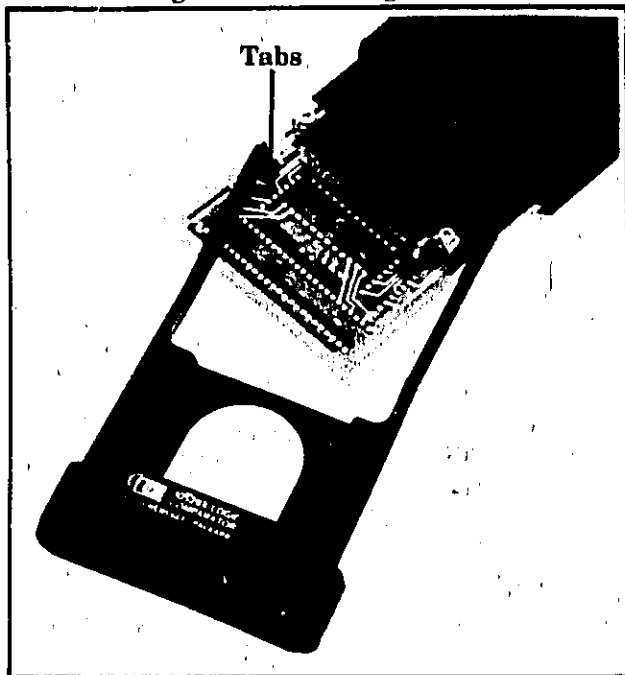
e. Slide the case end plate up the clip cable and fasten the end plate to the board with two screws and nuts.

NOTE

Be sure end plate is right side up.
Holes in plate must match threaded holes in case.

f. Push the end plate flush with the case and fasten the plate to the case with two screws.

Figure 5-3. Removing Drawer



5-9. IN-CABINET PERFORMANCE CHECK WITH SELF TEST CARD

5-10. With the logic comparator self test card all circuits in the comparator can be tested for proper operation. Open the drawer in the comparator and insert the self test card as shown in Figure 5-4. Gently close the drawer while guiding plug end of a self test card into connector of main board. Connect a 5-volt DC power source to the terminals marked +5V and GND on the test card. (See Figure 5-5.) This is test mode 1. All of the LED's will blink on and off about once every two seconds if the comparator is working properly. If any or all LED's do not blink, something is wrong. To check the IC clip and cable, connect the IC clip on the dummy IC between the "+5" and "GND" terminals of the test card. All LED's should blink on for alternately long and short periods. This is test mode two. If one or more LED's blink the same as in test mode one, this indicates an open circuit somewhere from that IC clip pin to the corresponding logic channel on the main board or LED board.

5-11. TROUBLESHOOTING

5-12: Use the self test card to find the cause of a malfunctioning logic comparator.

5-13. COMPARATOR TROUBLESHOOTING

5-14. Use the following procedure to diagnose component failure in the logic comparator.

- a. Install test card and apply power.
- b. The "ON" LED should remain lit and the other 16 LED's should flash about once every two seconds.
- c. If all 16 remain lit or unlit, refer to test card troubleshooting. If one (or more) do not light or are lit constantly, check that particular channel's signal flow with a 10525A Logic Probe. Compare the defective channel with a channel working properly.

Figure 5-4. Comparator With Self-Test Card

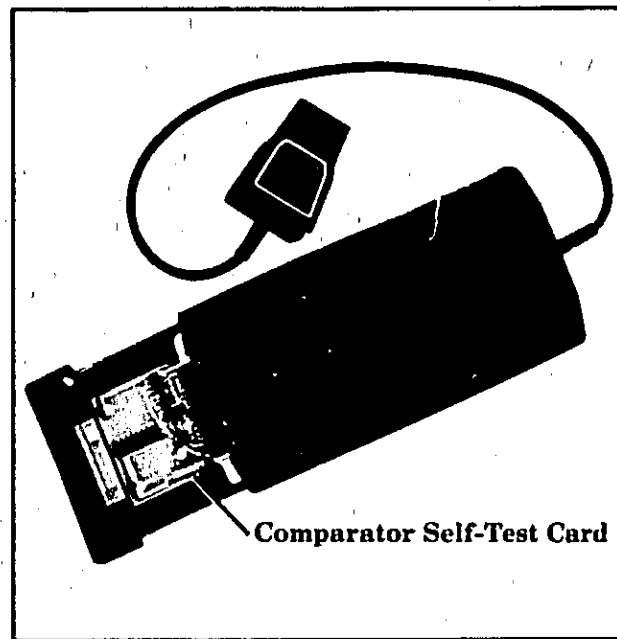
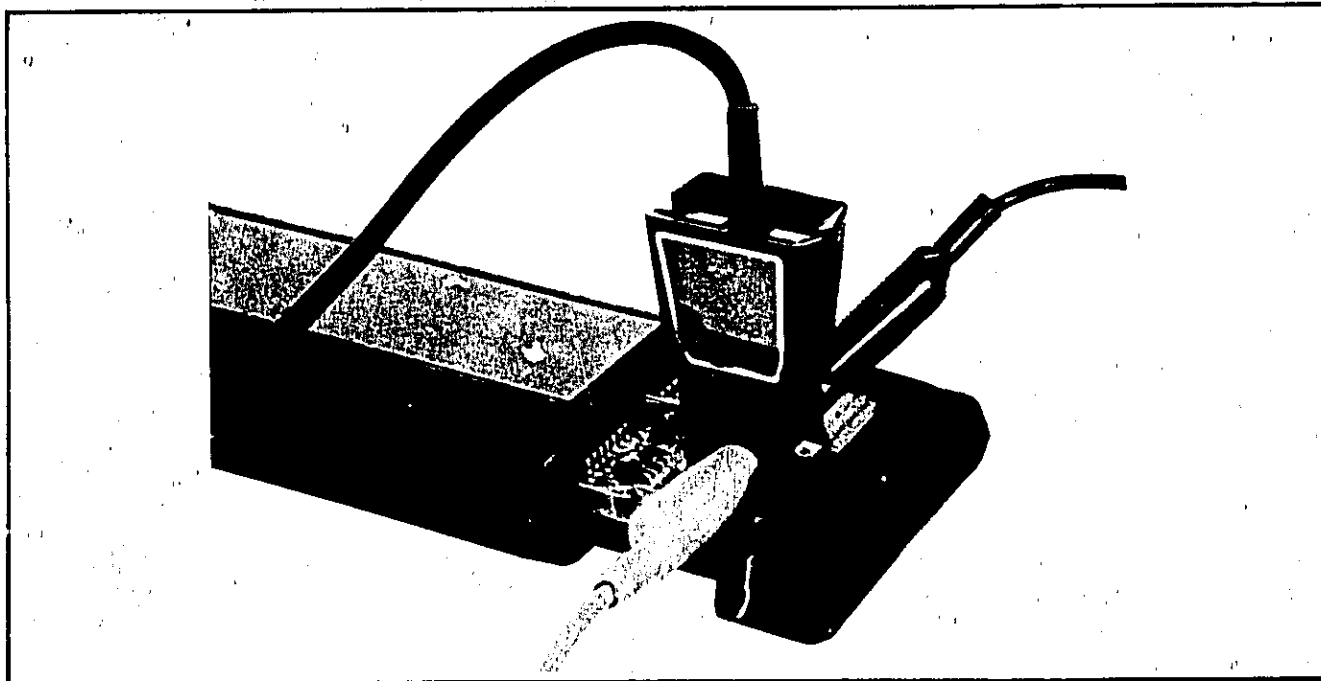


Figure 5-5. Comparator, Self-Test Card, and IC Test Clip (Test Mode Two)



5-15. SELF TEST CARD TROUBLESHOOTING

5-16. Use the following procedure to troubleshoot the self test card.

- a. Apply 5V power and check test point C with oscilloscope or logic probe.
- b. If not okay, check test points B and A. Refer to Figure 8-2 for proper waveform. Replace defective component in chain.
- c. If test point C is okay, check D and E, F and G. Replace the defective component.

NOTE

Test Point E is the differentiated Q output of U1A. Because of the very fast rise times and the slow repetition rate, use of the Logic Probe is necessary to view this signal.

5-17. REPAIR

5-18. Printed Circuit Soldering and Component Replacement

NOTE

The comparator's main printed circuit board has three layers of printed wiring in a sandwich form. The middle layer is not easily seen.

5-19. Component-lead holes in the circuit boards have conductors on opposite sides of the board. To prevent damage to this plating and the replacement component, apply heat sparingly, and work carefully. The following replacement procedure is recommended.

- a. Cut wires if necessary to remove defective component.

- b. Melt solder in component-lead holes. Use clean dry soldering iron and a vacuum-type solder remover to remove excess solder. Clean holes with a wooden

toothpick or splinter. Do not use metal tool for cleaning as this may damage through-hole plating.

c. Bend leads of replacement component to the correct shape and insert into component-lead holes. Using heat and solder sparingly, solder leads in place. Heat may be applied to either side of the board, but do not press soldering iron hard against the board.

d. Breaks in the through-hole plating are indicated by separation of the round conductor pad from either side of the board. To repair breaks, press conductor pad against board and solder replacement component lead to conductor pad on both sides of board.

5-20. Replacing Integrated Circuits

5-21. Following are two recommended methods of replacing integrated circuits:

a. *Solder Gobbler.* This is the best method. Solder is removed from the board by a hollow tip soldering

iron connected to a vacuum source. The IC is removed intact, so it may be re-installed if found to be operative.

b. *Clip Out.* This method should be used as a last resort only. Clip the leads as close to the case as possible. With a soldering iron and long-nose pliers, carefully remove the wires from each hole. Clean holes with a round wooden toothpick.

5-22. Replacing Clip Cover

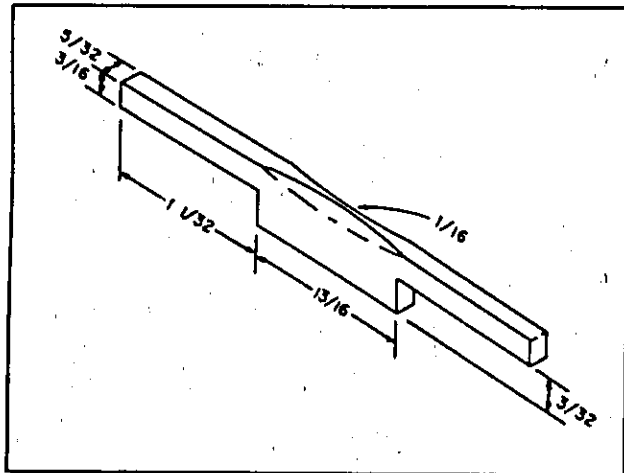
5-23. The clip cover for the logic comparator is subject to permanent damage when exposed to excessive heat. When replacing any item, extreme care must be exercised to prevent damage to the internal parts. The following steps tell how to replace the covers.

5-24. DISASSEMBLY

- a. Place the clip covers across a support so the cable is not restricted.
- b. Insert a flat blade screwdriver or tool as shown in Figure 5-6 between the cover halves.

- c. Hold the clip small end firmly closed.
- d. Press down firmly on the point of the screwdriver forcing the body out of the cover.

Figure 5-6. Extractor Tool



5-25. ASSEMBLY

- a. Place the inside of the cover halves facing each other with the pin on one side opposite the hole on the other.
- b. Place the cover teeth end down on a table.
- c. Push gently as if to slide one half past the other until the sides snap together.
- d. Squeeze the spring tips and insert into cover. Install 2 springs each side.
- e. Rotate the coil part of the spring down into the cover assembly.
- f. Position the spring coil part against the flat side of the cover with the ends in the grooves.
- g. Remove the protective paper from the foil labels and place the adhesive side on the cover face.

NOTE

A pad of rubber $3/16'' \times 3/4'' \times 1/2''$ will be required. This can be cut from a regular pencil eraser or plastic eraser.

- h. Insert the rubber pad between the covers just behind the pin guides.
- i. Lift the edge of the printed circuit card causing the tips of the pins to separate.
- j. Locate the pin with a gray wire. This is pin number one and must be at position "1" identified on the cover.
- k. Insert the pins into the covers guiding them into their respective grooves.

- l. Squeeze the teeth end of the cover.
- m. Push the body (rock gently from side to side) until the pins are seated in the cover guides.
- n. Place the cover teeth end down.
- o. Remove the rubber pad.
- p. Push down with your thumbs until the body snaps into the cover.
- q. Test the comparator for proper operation.

PARTS LIST

SECTION VI REPLACEABLE PARTS

6-1. INTRODUCTION

6-2. This section contains information for ordering replacement parts. Table 6-1 lists parts in alpha-numerical order of their reference designators and provides the following information on each part.

- a. HP part number and description
- b. Typical manufacturer of the part in a five-digit code; see list of manufacturers in Table 6-2.
- c. Manufacturer's part number
- d. Total quantity used in instrument is given at first listing of each part under Qty heading.

6-3. ORDERING INFORMATION

6-4. To obtain replacement parts, address order or inquiry to your local Hewlett-Packard Sales and Service Office (see lists at rear of this manual for addresses). Identify parts by their Hewlett-Packard part numbers.

- 6-5. To obtain a part that is not listed, include:
- a. Instrument model number
 - b. Instrument serial number
 - c. Description of the part
 - d. Function and location of the part.

Table 6-1. Replaceable Parts

Reference Designation	HP Part Number	Qty	Description	Mfr Code	Mfr Part Number
A1	10529-60003	1	BOARD ASSY:DISPLAY	28480	10529-60003
A1C1	0180-0291	1	C:FXD ELECT 1.0 UF 10K 35VDCW	56289	1500105X0015A2-DYS
A1C2	0180-0210	16	C:FXD ELECT 3.3 UF 20K 15VDCW	56289	1500335X0015A2-DYS
A1C3	0180-0210		C:FXD ELECT 3.3 UF 20K 15VDCW	56289	1500335X0015A2-DYS
A1C4	0180-0210		C:FXD ELECT 3.3 UF 20K 15VDCW	56289	1500335X0015A2-DYS
A1C5	0180-0210		C:FXD ELECT 3.3 UF 20K 15VDCW	56289	1500335X0015A2-DYS
A1CR1	1902-3036	16	DIODE:BREAKDOWN 3.16V 5K	04713	5210939-38
A1CR2	1902-3036		DIODE:BREAKDOWN 3.16V 5K	04713	5210939-38
A1CR3	1902-3036		DIODE:BREAKDOWN 3.16V 5K	04713	5210939-38
A1CR4	1902-3036		DIODE:BREAKDOWN 3.16V 5K	04713	5210939-38
A1DS1	1990-0324	17	DIODE:VISIBLE LIGHT EMITTER	28480	1990-0324
A1DS2	1990-0324		DIODE:VISIBLE LIGHT EMITTER	28480	1990-0324
A1DS3	1990-0324		DIODE:VISIBLE LIGHT EMITTER	28480	1990-0324
A1DS4	1990-0324		DIODE:VISIBLE LIGHT EMITTER	28480	1990-0324
A1DS5	1990-0324		DIODE:VISIBLE LIGHT EMITTER	28480	1990-0324
A1DS6	1990-0324		DIODE:VISIBLE LIGHT EMITTER	28480	1990-0324
A1DS7	1990-0324		DIODE:VISIBLE LIGHT EMITTER	28480	1990-0324
A1DS8	1990-0324		DIODE:VISIBLE LIGHT EMITTER	28480	1990-0324
A1DS9	1990-0324		DIODE:VISIBLE LIGHT EMITTER	28480	1990-0324
A1DS10	1990-0324		DIODE:VISIBLE LIGHT EMITTER	28480	1990-0324
A1DS11	1990-0324		DIODE:VISIBLE LIGHT EMITTER	28480	1990-0324
A1DS12	1990-0324		DIODE:VISIBLE LIGHT EMITTER	28480	1990-0324
A1DS13	1990-0324		DIODE:VISIBLE LIGHT EMITTER	28480	1990-0324
A1DS14	1990-0324		DIODE:VISIBLE LIGHT EMITTER	28480	1990-0324
A1DS15	1990-0324		DIODE:VISIBLE LIGHT EMITTER	28480	1990-0324
A1DS16	1990-0324		DIODE:VISIBLE LIGHT EMITTER	28480	1990-0324
A1DS17	1990-0324		DIODE:VISIBLE LIGHT EMITTER	28480	1990-0324
A1R1	0683-4715	23	R:FXD COMP 470 OHM 5K 1/4W	01121	CB 4715
A1R2	0683-4715		R:FXD COMP 470 OHM 5K 1/4W	01121	CB 4715
A1R3	0683-4715		R:FXD COMP 470 OHM 5K 1/4W	01121	CB 4715

Table 6-1. Replaceable Parts (Cont'd)

Reference Designation	HP Part Number	Qty	Description	Mfr Code	Mfr Part Number
A1R4	06R3-4715		REFXD COMP 470 OHM 5% 1/4W	01121	CB 4715
A1R5	06R3-4715		REFXD COMP 470 OHM 5% 1/4W	01121	CB 4715
A1R6	06R3-4715		REFXD COMP 470 OHM 5% 1/4W	01121	CB 4715
A1R7	06R3-4715		REFXD COMP 470 OHM 5% 1/4W	01121	CB 4715
A1R8	06R3-4715		REFXD COMP 470 OHM 5% 1/4W	01121	CB 4715
A1R9	06R3-4715		REFXD COMP 470 OHM 5% 1/4W	01121	CB 4715
A1K10	069R-6984	4	REFXD COMP 470 OHM 5% 1/8W	2R4R0	069R-6984
A1R11	069R-7935	4	REFXD COMP 68K OHM 5% 1/8W	01121	BP 6R35
A1R12	069R-6984		REFXD COMP 470 OHM 5% 1/8W	2R4R0	069R-6984
A1R13	069R-7935		REFXD COMP 68K OHM 5% 1/8W	01121	BP 6R35
A1R14	069R-5984		REFXD COMP 470 OHM 5% 1/8W	2R4R0	069R-6984
A1R15	069R-7935		REFXD COMP 68K OHM 5% 1/8W	01121	BP 6R35
A1R16	069R-6984		REFXD COMP 470 OHM 5% 1/8W	2R4R0	069R-6984
A1R17	069R-7935		REFXD COMP 68K OHM 5% 1/8W	01121	BP 6R35
A1R18	06R3-4715		REFXD COMP 470 OHM 5% 1/4W	01121	CB 4715
A1R19	06R3-4715		REFXD COMP 470 OHM 5% 1/4W	01121	CB 4715
A1R20	06R3-4715		REFXD COMP 470 OHM 5% 1/4W	01121	CB 4715
A1R21	06R3-4715		REFXD COMP 470 OHM 5% 1/4W	01121	CB 4715
A1U1	1R20-032R	4	IC:TTL QUAD 7-INPT NOR GATF	01295	744447
A1U2	1R20-058R	3	IC:DIGITAL TTL HEX CONVERTFR	2R4R0	1R20-058R
A7	10529-6000Z	1	BOARD ASSY, MAIN SERIES 1240	2R4R0	10529 6000Z
A7C1	0150-0071	16	CIFXD CER 400 PF 5% 1000VDCW	562R9	C016A102FA01J527 27H
A7C2	0180-0210		CIFXD ELECT 3.3 UF 20% 15VDCW	562R9	1503335X0015A2 0Y5
A7C3	0150-0071		CIFXD CER 400 PF 5% 1000VDCW	562R9	C016A102FA01J527 27H
A7C4	0180-0210		CIFXD ELECT 3.3 UF 20% 15VDCW	562R9	1503335X0015A2 0Y5
A7C5	0150-0071		CIFXD CER 400 PF 5% 1000VDCW	562R9	C016A102FA01J527 27H
A7C6	0180-0210		CIFXD ELECT 3.3 UF 20% 15VDCW	562R9	1503335X0015A2 0Y5
A7C7	0150-0071		CIFXD CER 400 PF 5% 1000VDCW	562R9	C016A102FA01J527 27H
A7C8	0180-0210		CIFXD ELECT 3.3 UF 20% 15VDCW	562R9	1503335X0015A2 0Y5
A7C9	0150-0071		CIFXD CER 400 PF 5% 1000VDCW	562R9	C016A102FA01J527 27H

Table 6-1. Replaceable Parts (Cont'd)

Reference Designation	HP Part Number	Qty	Description	Mfr Code	Mfr Part Number
A2C10	0180-0210		C:FXD ELECT 3.3 UF 20K 15VDCW	56289	150335X001542-DYS
A2C11	0150-0071		C:FXD CER 400 PF 5K 1000VDCW	56289	C016R102F401J527-C0H
A2C12	0180-0210		C:FXD ELECT 3.3 UF 20K 15VDCW	56289	150335X001542-DYS
A2C13	0150-0071		C:FXD CER 400 PF 5K 1000VDCW	56289	C016R102F401J527-C0H
A2C14	0180-0210		C:FXD ELECT 3.3 UF 20K 15VDCW	56289	150335X001542-DYS
A2C15	0150-0071		C:FXD CER 400 PF 5K 1000VDCW	56289	C016R102F401J527-C0H
A2C16	0180-0210		C:FXD ELECT 3.3 UF 20K 15VDCW	56289	150335X001542-DYS
A2C17			NOT ASSIGNED		
A2C18	0150-0071		C:FXD CER 400 PF 5K 1000VDCW	56289	C016R102F401J527-C0H
A2C19	0150-0071		C:FXD CER 400 PF 5K 1000VDCW	56289	C016R102F401J527-C0H
A2C20	0150-0071		C:FXD CER 400 PF 5K 1000VDCW	56289	C016R102F401J527-C0H
A2C21	0150-0071		C:FXD CER 400 PF 5K 1000VDCW	56289	C016R102F401J527-C0H
A2C22	0150-0071		C:FXD CER 400 PF 5K 1000VDCW	56289	C016R102F401J527-C0H
A2C23	0180-0210		C:FXD ELECT 3.3 UF 20K 15VDCW	56289	150335X001542-DYS
A2C24	0150-0071		C:FXD CER 400 PF 5K 1000VDCW	56289	C016R102F401J527-C0H
A2C25	0180-0210		C:FXD ELECT 3.3 UF 20K 15VDCW	56289	150335X001542-DYS
A2C26	0150-0071		C:FXD CER 400 PF 5K 1000VDCW	56289	C016R102F401J527-C0H
A2C27	0180-0210		C:FXD ELECT 3.3 UF 20K 15VDCW	56289	150335X001542-DYS
A2C28	0150-0071		C:FXD CER 400 PF 5K 1000VDCW	56289	C016R102F401J527-C0H
A2C29	0180-0210		C:FXD ELECT 3.3 UF 20K 15VDCW	56289	150335X001542-DYS
A2CR1	1902-3036		DIODE: BREAKDOWN 3.16V 5K	04713	5210939 3R
A2CR2	1902-3036		DIODE: BREAKDOWN 3.16V 5K	04713	5210939 3R
A2CR3	1902-3036		DIODE: BREAKDOWN 3.16V 5K	04713	5210939 3R
A2CR4	1902-3036		DIODE: BREAKDOWN 3.16V 5K	04713	5210939 3R
A2CR5	1902-3036		DIODE: BREAKDOWN 3.16V 5K	04713	5210939 3R
A2CR6	1902-3036		DIODE: BREAKDOWN 3.16V 5K	04713	5210939 3R
A2CR7	1902-3036		DIODE: BREAKDOWN 3.16V 5K	04713	5210939 3R
A2CR8	1902-3036		DIODE: BREAKDOWN 3.16V 5K	04713	5210939 3R
A2CR9	1901-0040	18	DIODE: SILICON 30MA 30WV	07263	F0610RP
A2CR10	1902-3036		DIODE: BREAKDOWN 3.16V 5K	04713	5210939 3R

Table 6-1. Replaceable Parts (Cont'd)

Reference Designation	HP Part Number	Qty	Description	Mfr Code	Mfr Part Number
A2C411	1902-3036		DIODE: BREAKDOWN 3.16V 5%	04713	5710939 3R
A2C412	1902-3036		DIODE: BREAKDOWN 3.16V 5%	04713	5710939 3R
A2C413	1902-3036		DIODE: BREAKDOWN 3.16V 5%	04713	5710939 3R
A2J1	1251-2859	1	CONNECTOR: P.C.		
A2J2	1251-2860	1	CONNECTOR: PC (2 X 18) 36 CONTACT	05574	2VH18/1JVS PT ANGLE
A2Q1	1853-0016	2	TSTR: SI PNP	80131	2V361R
A2R1	0698-5426	16	R:FXD COMP 10K OHM 10% 1/8W	28480	0698-5426
A2R2	0683-6835	12	R:FXD COMP 68K OHM 5% 1/4W	01121	CR 6835
A2R3	0698-5426		R:FXD COMP 10K OHM 10% 1/8W	28480	0698-5426
A2R4	0683-6835		R:FXD COMP 68K OHM 5% 1/4W	01121	CR 6835
A2R5	0698-5426		R:FXD COMP 10K OHM 10% 1/8W	28480	0698-5426
A2R6	0683-6835		R:FXD COMP 68K OHM 5% 1/4W	01121	CR 6835
A2R7	0698-5426		R:FXD COMP 10K OHM 10% 1/8W	28480	0698-5426
A2R8	0683-6835		R:FXD COMP 68K OHM 5% 1/4W	01121	CR 6835
A2R9	0698-5426		R:FXD COMP 10K OHM 10% 1/8W	28480	0698-5426
A2R10	0683-6835		R:FXD COMP 68K OHM 5% 1/4W	01121	CR 6835
A2R11	0698-5426		R:FXD COMP 10K OHM 10% 1/8W	28480	0698-5426
A2R12	0683-6835		R:FXD COMP 68K OHM 5% 1/4W	01121	CR 6835
A2R13	0698-5426		R:FXD COMP 10K OHM 10% 1/8W	28480	0698-5426
A2R14	0683-6835		R:FXD COMP 68K OHM 5% 1/4W	01121	CR 6835
A2R15	0698-5426		R:FXD COMP 10K OHM 10% 1/8W	28480	0698-5426
A2R16	0683-6835		R:FXD COMP 68K OHM 5% 1/4W	01121	CR 6835
A2R17	0683-2215	2	R:FXD COMP 220 OHM 5% 1/4W	01121	CR 2215
A2R18	0698-5426		R:FXD COMP 10K OHM 10% 1/8W	28480	0698-5426
A2R19	0698-5426		R:FXD COMP 10K OHM 10% 1/8W	28480	0698-5426
A2R20	0698-5426		R:FXD COMP 10K OHM 10% 1/8W	28480	0698-5426
A2R21	0698-5426		R:FXD COMP 10K OHM 10% 1/8W	28480	0698-5426
A2R22	0698-5426		R:FXD COMP 10K OHM 10% 1/8W	28480	0698-5426
A2R23	0683-6835		R:FXD COMP 68K OHM 5% 1/4W	01121	CR 6835
A2R24	0698-5426		R:FXD COMP 10K OHM 10% 1/8W	28480	0698-5426

Table 6-1. Replaceable Parts (Cont'd)

Reference Designation	HP Part Number	Qty	Description	Mfr Code	Mfr Part Number
A2R25	0683-6835		REFXD COMP 68K DMM 5% 1/4W	01121	CR 6835
A2R26	0698-5426		REFXD COMP 10K DMM 10% 1/8W	28480	0698-5426
A2R27	0683-6835		REFXD COMP 68K DMM 5% 1/4W	01121	CR 6835
A2R28	0698-5426		REFXD COMP 10K DMM 10% 1/8W	28480	0698-5426
A2R29	0683-6835		REFXD COMP 68K DMM 5% 1/4W	01121	CR 6835
A2J1	1820-0328		IC:TTL QUAD 2-INPT NOR GATE	01295	5N4467
A2J2	1820-0598	4	IC:DIGITAL TTL QUAD 2-INPT EXCL OR GATE	28480	1820-0598
A2J3	1820-0586		IC:DIGITAL TTL HEX CONVERTER	28480	1820-0586
A2J4	1820-0586		IC:DIGITAL TTL HEX CONVERTER	28480	1820-0586
A2J5	1820-0598		IC:DIGITAL TTL QUAD 2-INPT EXCL OR GATE	28480	1820-0598
A2U6	1820-0328		IC:TTL QUAD 2-INPT NOR GATE	01295	5N4467
A2J7	1820-0598		IC:DIGITAL TTL QUAD 2-INPT EXCL OR GATE	28480	1820-0598
A2U8	1820-0598		IC:DIGITAL TTL QUAD 2-INPT EXCL OR GATE	28480	1820-0598
A2U9	1820-0328		IC:TTL QUAD 2-INPT NOR GATE	01295	5N4467
A2E	2200-0091	2	SCREW:ST 4-40 X .562"	00000	080
A27	2260-0002	2	NUT:HEX FOR #4 HDW	00000	080
A3	10529-60004	1	BOARD ASSY:TEST	28480	10529-60004
A3C1	0180-0229	1	C:FXD ELECT 33 UF 10% 10VDCW	28480	0180-0229
A3C2	0180-2207	1	C:FXD MICA 300 PF 300 VDCW 5%	28480	0180-2207
A3C81	1901-0040		DIODE:SILICON 30MA 30MV	07263	FDG1088
A3C82	1901-0040		DIODE:SILICON 30MA 30MV	07263	FDG1088
A3C83	1901-0040		DIODE:SILICON 30MA 30MV	07263	FDG1088
A3C84	1901-0040		DIODE:SILICON 30MA 30MV	07263	FDG1088
A3C85	1901-0040		DIODE:SILICON 30MA 30MV	07263	FDG1088
A3C86	1901-0040		DIODE:SILICON 30MA 30MV	07263	FDG1088
A3C87	1901-0040		DIODE:SILICON 30MA 30MV	07263	FDG1088
A3C88	1901-0040		DIODE:SILICON 30MA 30MV	07263	FDG1088
A3C89	1901-0040		DIODE:SILICON 30MA 30MV	07263	FDG1088
A3C90	1901-0040		DIODE:SILICON 30MA 30MV	07263	FDG1088
A3C91	1901-0040		DIODE:SILICON 30MA 30MV	07263	FDG1088
A3C92	1901-0040		DIODE:SILICON 30MA 30MV	07263	FDG1088

Table 6-1. Replaceable Parts (Cont'd)

Reference Designation	HP Part Number	Qty	Description	Mfr Code	Mfr Part Number
A3C12	1901-0040		DIODE: SILICON 30MA 30MV	07263	FDG10FR
A3C13	1901-0040		DIODE: SILICON 30MA 30MV	07263	FDG10FR
A3C14	1901-0040		DIODE: SILICON 30MA 30MV	07263	FDG10FR
A3C15	1901-0040		DIODE: SILICON 30MA 30MV	07263	FDG10FR
A3C16	1901-0040		DIODE: SILICON 30MA 30MV	07263	FDG10FR
A3C17	1901-0040		DIODE: SILICON 30MA 30MV	07263	FDG10FR
A3J1	1260-0339	1	INTEGRATED CIRCUIT DUMMY	28480	1260-0339
A3J1	1855-0010	1	TSTR:SI	80131	242646
A3J2	1853-0016	1	TSTR:SI PNP	80131	243638
A3J3	1854-0019	1	TSTR:SI NPN	28480	1854-0019
A3R1	0683-1035	1	R:FXD COMP 10K OHM 5% 1/4W	01121	CR 1035
A3R2	0683-2215	1	R:FXD COMP 220 OHM 5% 1/4W	01121	CR 2215
A3R3	0683-2015	1	R:FXD COMP 200 OHM 5% 1/4W	01121	CR 2015
A3R4	0683-4315	1	R:FXD COMP 430 OHM 5% 1/4W	01121	CR 4315
A3R5	0683-4725	1	R:FXD COMP 4700 OHM 5% 1/4W	01121	CR 4725
A3R6	0683-3025	1	R:FXD COMP 3000 OHM 5% 1/4W	01121	CR 3025
A3R7	0683-2025	1	R:FXD COMP 2000 OHM 5% 1/4W	01121	CR 2025
A3U2	1820-0054	1	IC: TTL QUAD 2-INPUT NAND GATE	01295	544342
A3U1	1820-0075	1	IC: TTL DUAL MASTER/SLAVE FF	01295	544353
WI	10529-60001	1	CABLE ASSY: MAIN (includes cable, IC clip connector, case end plate and strain relief).	28480	10529-60001
			MISCELLANEOUS PARTS		
	0624-0227	2	SCREW: TAP 4-40 THREAD	00000	060
	10529-00002	1	MASK: L.E.D.	28480	10529-00002
	10529-20005	10	BOARD: BLANK PC REF IC	28480	10529-20005
	10529-60005	1	CASE: EXT (INCLUDES WINDOW)	28480	10529-60005
A1	10529-20003		Blank Board	28480	10529-20003
A2	10529-20002		Blank Board	28480	10529-20002
A3	10529-20004		Blank Board	28480	10529-20004
	10529-40001	1	DRAWER	28480	10529-40001
	10529-40003	1	WINDOW	28480	10529-40003

Table 6-1. Replaceable Parts (Cont'd)

Reference Designation	HP Part Number	Qty	Description	Mfr Code	Mfr Part Number
	8561-0008	1	DRILL: 1/8"	26480	8561-0008
	0370-0125	1	KNOB (FOR 8561-0008)	26480	0370-0125
	10528-40001	2	CLIP BOARD ASSEMBLY	26480	10528-40001
	10528-20002	4	COVER	26480	10528-20002
	7120-2725	1	SPRING	26480	7120-2725
	7120-2727	1	LABEL: 7 VOLT	26480	7120-2727
	10529-20001	2	1 LABEL	26480	10529-20001
	10529-20007	16	PRINTED CIRCUIT BOARD	26480	10529-20007
	10529-40005	1	CONTACT	26480	10529-40005
			SUPPORT	26480	

Table 6-2. Code List of Manufacturers

MFR NO.	MANUFACTURER NAME	ADDRESS	ZIP CODE
00000	NO M/F DESCRIPTION FOR THIS MFG NUMBER		
00000	U.S.A. COMMON	ANY SUPPLIER OF U.S.A.	
01171	ALLEN BRADLEY CO.	MILWAUKEE, WIS.	53204
01295	TEXAS INSTRUMENTS INC. SEMICONDUCTOR COMPONENTS DIV.	DALLAS, TEX.	75231
04713	MOTOROLA SEMICONDUCTOR PROD. INC.	PHOENIX, ARIZ.	85008
05574	VIKING IND. INC.	CHATSWORTH, CALIF.	91311
07263	FAIRCHILD CAMERA & INST. CORP. SEMICONDUCTOR DIV.	MOUNTAIN VIEW, CALIF.	94040
28480	HEWLETT-PACKARD COMPANY	PALO ALTO, CALIF.	94304
50289	SPRAGUE ELECTRIC CO.	N. ADAMS, MASS.	01247
72136	ELECTRO MOTIVE MFG. CO. INC.	WILLIAMTIC, CONN.	06226
80131	ELECTRONIC INDUSTRIES ASSOCIATION	WASHINGTON D.C.	20006

**BACK DATING
MANUAL
CHANGES**

SECTION VII

OPTIONS AND MANUAL CHANGES

7-1. INTRODUCTION

7-2. Options available for the Comparator and applicability of this manual are given in this section.

7-3. OPTIONS

7-4. Option 001. Twenty additional blank reference boards.

7-5. Option 002. Twenty preprogrammed reference boards.

7-6. Option 003. External reference kit.

7-7. MANUAL CHANGES

7-8. This manual applies directly to 10529A Logic Comparator instruments with the serial prefix printed on the title page.

7-9. NEWER INSTRUMENTS

7-10. As changes are made, newer logic comparators may have serial number prefixes not listed in this manual. A "manual changes" sheet listing the correct serial prefix and describing changes should be in this manual. If the manual change sheet is missing, contact your nearest Hewlett-Packard Sales and Service Office as listed in the back of this manual.

SCHEMATIC DIAGRAMS

SECTION VIII CIRCUIT DIAGRAMS

8-1. INTRODUCTION

8-2. This section contains the following information:

- a. Schematic diagram general notes.
- b. Test Card Waveforms.
- c. Logic Comparator schematics.
- d. Component Location Photos.

8-3. WAVEFORMS

8-4. Figure 8-2 shows oscilloscope waveform photographs from the comparator test card. A Model 181A Hewlett-Packard storage oscilloscope with a 1830A vertical amplifier, a 1124A probe and 10:1 divider, and a 1820A time base was used for the waveforms.

Figure 8-1. Schematic Diagram Notes

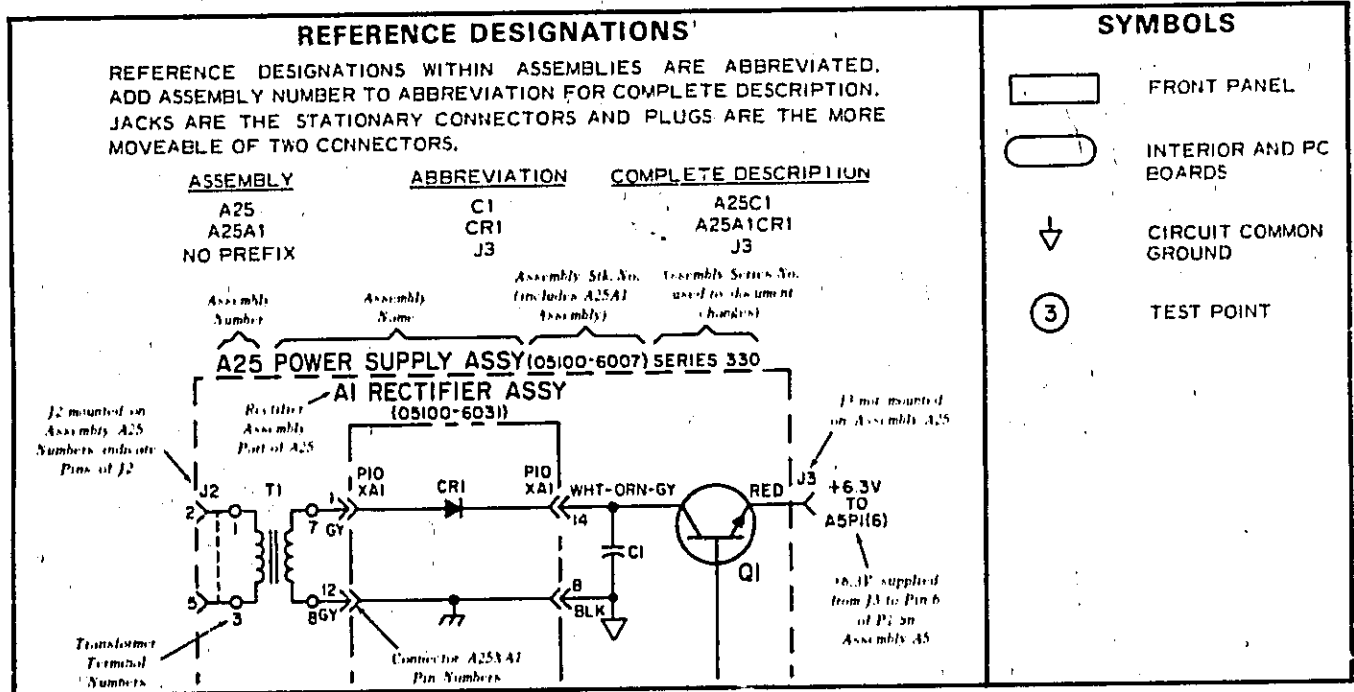


Figure 8-2. A3 Test Card Waveforms (Cont'd)

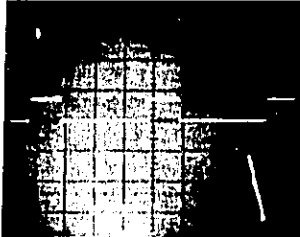
Waveform	Vertical	Time Base
G 	.5 VOLT/DIV +UP	.5 SEC/CM

Figure 8-2. A3 Test Card Waveforms (Cont'd)


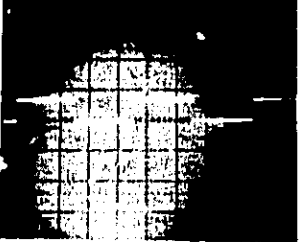
Waveform	Vertical	Time Base
C 	.5 VOLT/DIV +UP	.2 SEC/CM
D 	.5 VOLT/DIV +UP	.5 SEC/CM

Figure 8-2. A3 Test Card Waveforms (Cont'd)

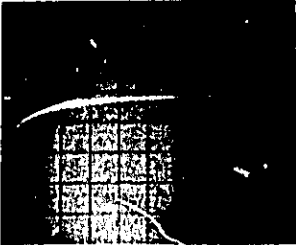
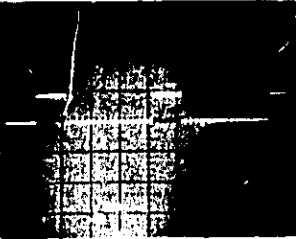
Waveform	Vertical	Time Base
E 	.2 VOLT/DIV	.1 MICROSECOND/CM a .022 μ fd capacitor added in series with A3C1 to increase the clock rate
F 	.5 VOLT/DIV +UP	.5 SEC/CM

Figure 8-2. A3 Test Card Waveforms (Cont'd)

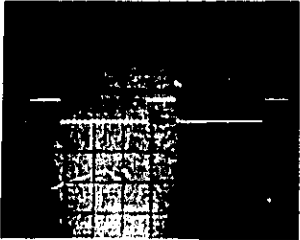
Waveform	Vertical	Time Base
G 	.5VOLT/DIV +UP	.5SEC/CM

Figure 8-3. Main Beard Component Locations

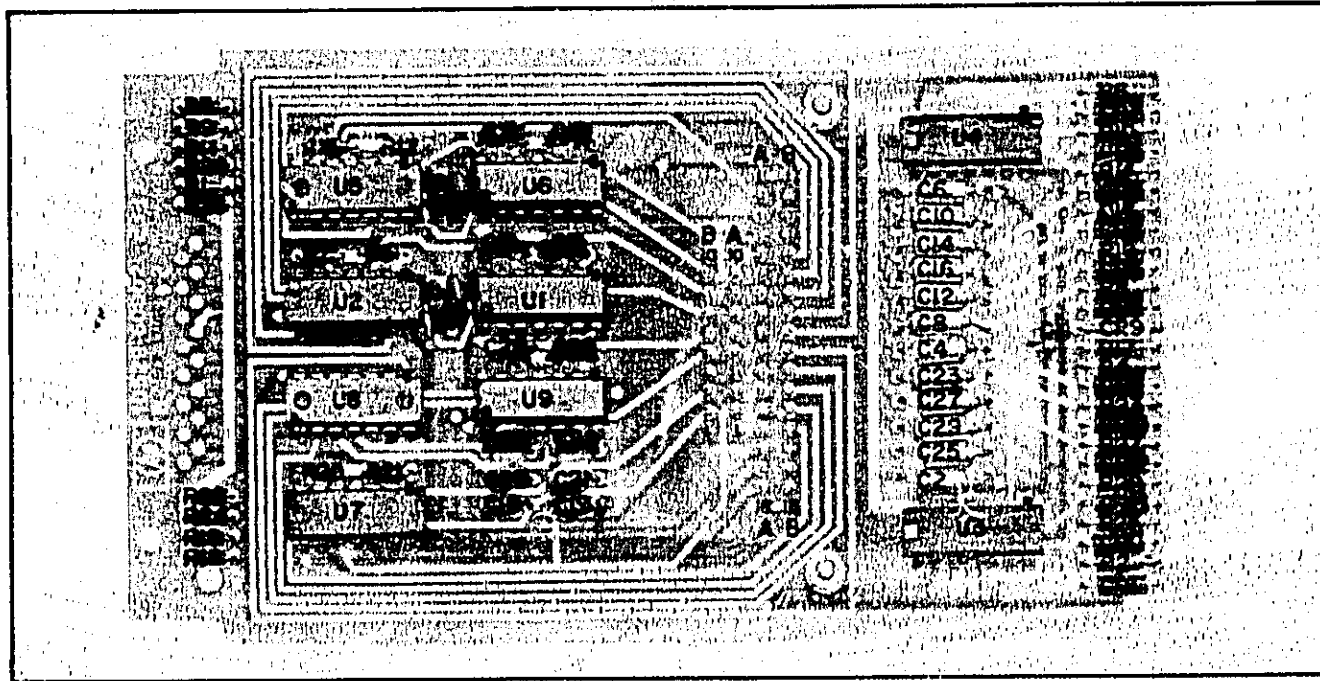
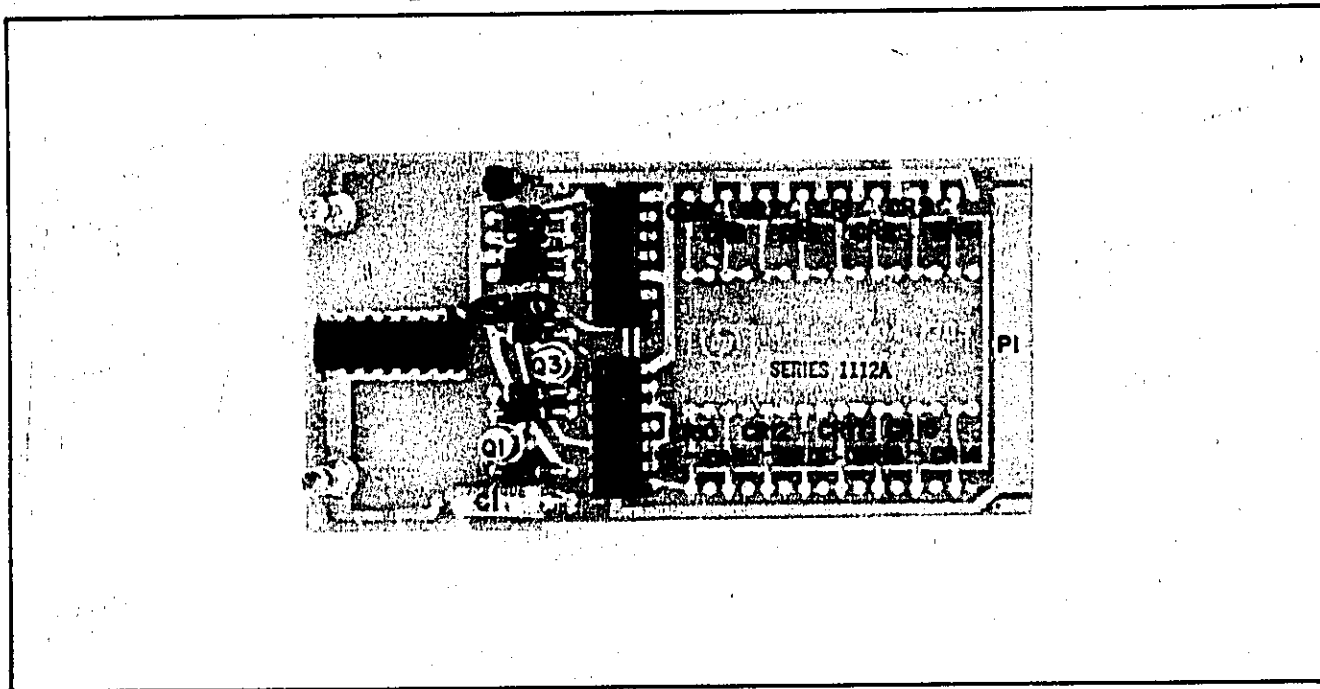


Figure 8-5. Self-Test Card Component Locations



NOTES

1. REFERENCE DESIGNATIONS WITHIN THIS ASSEMBLY ARE ABBREVIATED. ADD ASSEMBLY NUMBER TO ABBREVIATION FOR COMPLETE DESCRIPTION.
2. UNLESS OTHERWISE INDICATED:
RESISTANCE IN OHMS,
CAPACITANCE IN PICOFARADS.
3. ASTERISK (*) IN REFERENCE IC CAPD SCHEMATIC INDICATES CONDUCTING PATH THROUGH HOLE WHICH IS TO BE DRILLED OUT TO DISCONNECT REFERENCE IC OUTPUT PINS FROM CORRESPONDING IC OUTPUT PINS IN CIRCUIT BEING TESTED. ONLY IC OUTPUT PINS ARE TO BE DISCONNECTED BY DRILLING.
4. A2 CRI-CR8, CH10-CR13 AND A1 CH1-CH4 ZENER VOLTAGE IS 5.16 VOLTS.

REFERENCE DESIGNATIONS

NO PREFIX	A1	A2	A3
	CI-5 CR1-4 DS1-16	CI-29 CR1-13 JI-2	CI-2 CR1-17 JI PI
PI	PI	CI-3 RI-29 UI-2	CI-3 RI-7 UI, 2
WI	RI-21 UI, 2	CI RI-29 UI-9	CI-3 RI-7 UI, 2

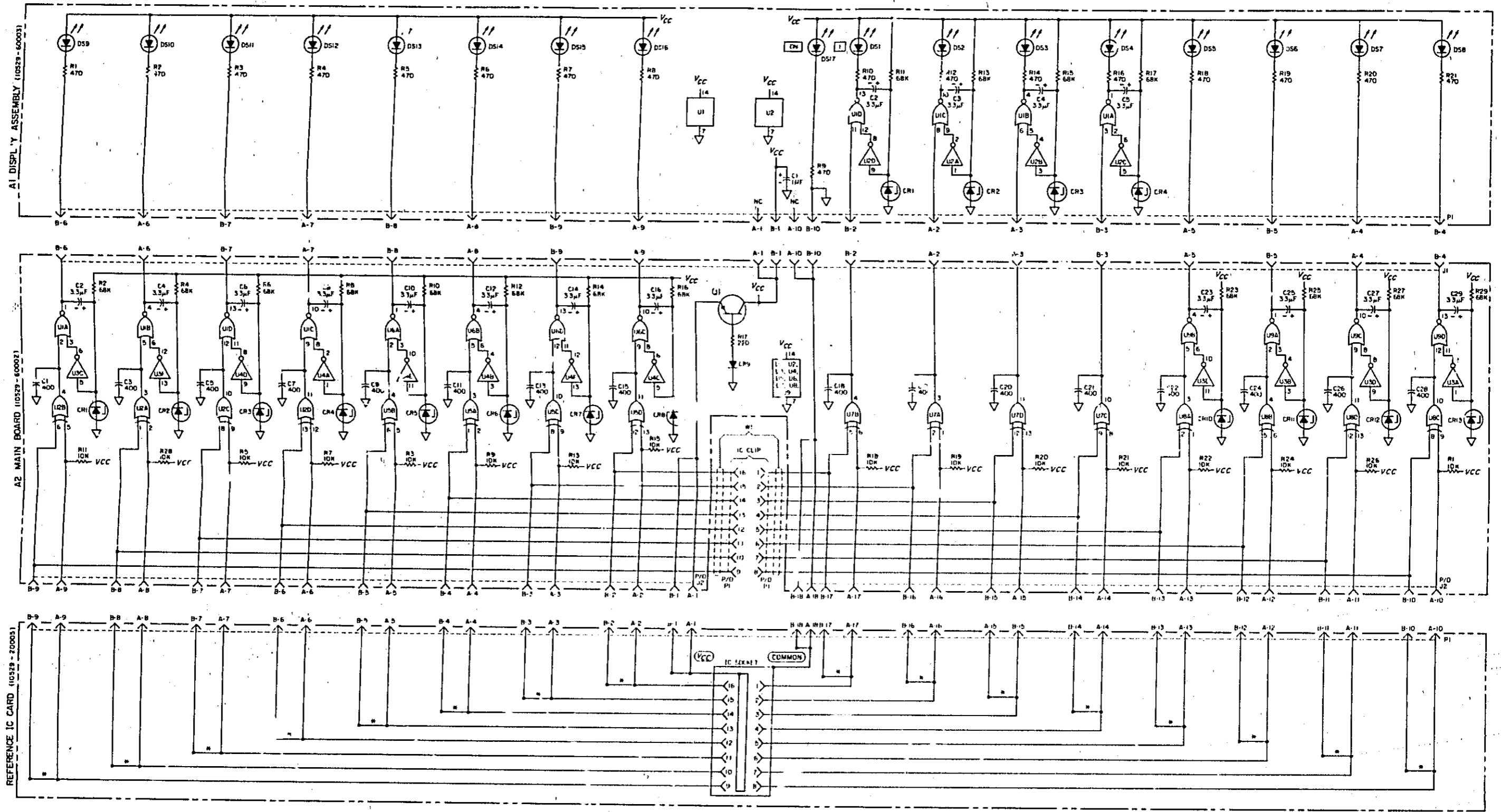
A2C17: NOT ASSIGNED

TABLE

REFERENCE DESIGNATIONS	HP PART NUMBERS
A1:	
CH1-4	1902 - 3036
DS1	1990 - 0310
UI	1820 - 0329
UC	1870 - 0586
A2:	
CR1-8, CH10-13	1902 - 3036
CR9	1901 - 0040
CI	1853 - 0016
UI, 6, 9	1820 - 0329
UI, 5, 7, 8	1870 - 0586
UI, 4	1870 - 0586
A3:	
CR1-17	1901 - 0040
CI	1853 - 0016
CR2	1853 - 0016
CR3	1854 - 0019
UI	1870 - 0586
UI	1870 - 0675

Figure 8-6

A1 DISPLAY BOARD
A2 MAIN BOARD
REFERENCE IC CARD



SCHEMATIC

DIAGRAMS

CON'T

Figure 8-6
A1 DISPLAY BOARD
A2 MAIN BOARD
REFERENCE IC CARD

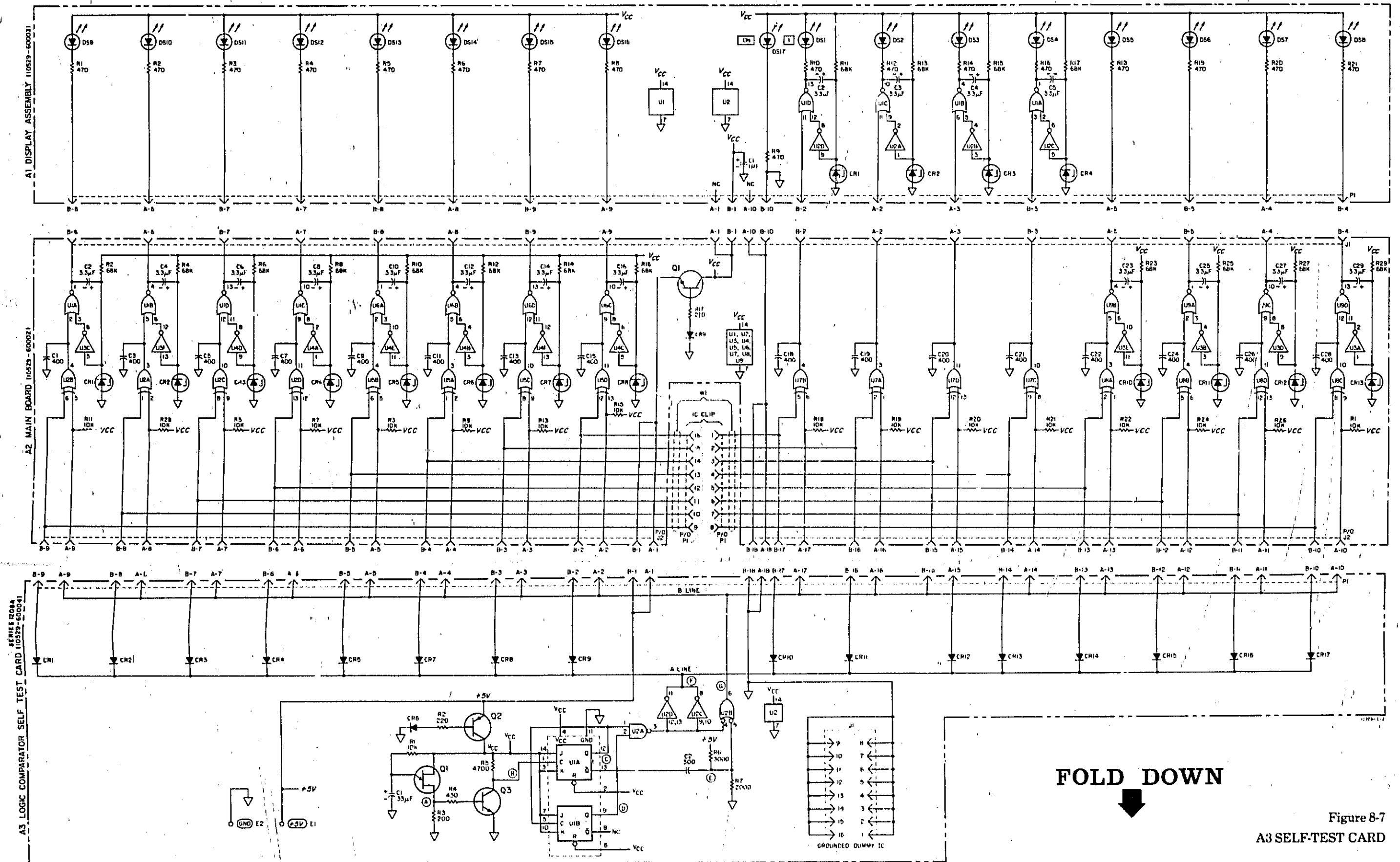


Figure 8-7
A3 SELF-TEST CARD

MANUAL CHANGES

MANUAL CHANGES

CHANGE DATE: May 5, 1983
 This change supersedes all earlier dated changes.

*** Make all corrections listed under ERRATA before making other changes.

*** Check following table for your instrument's serial prefix or series number and make listed change(s) to manual.

MANUAL DESCRIPTION
 * * * * *
 * INSTRUMENT: 10529A *
 * Logic Comparator *
 * Operating and Service Manual *
 * * * * *
 * SERIAL PREFIX: 1240A *
 * * * * *
 * DATE PRINTED: AUG 1973 *
 * HP PART NO: 10529-90005 *
 * MICROFICHE NO: 10529-90009 *
 * * * * *

# INDICATES NEW OR REVISED ITEM		> INDICATES ACTION TO BE TAKEN	
SERIAL PREFIX, SERIES NUMBER OR DATE CODE	MANUAL CHANGE(S)	SERIAL PREFIX, SERIES NUMBER OR DATE CODE	MANUAL CHANGE(S)
1424A	1		**
1444A	1,2		**
1940A	1,2,3		**
1940A	1,2,3,4		**
#2204A	1,2,3,4,5		**

(C10529AS) 5225-5804/B945/E=12387/4=12419/5=12378-14869



Insert this Warning after the Certification/Warranty and Assistance which is on the inside front cover.

WARNING

This product should be connected to a power source that is sufficiently isolated from the main supply to prevent the risk of electric shock.

To further reduce the risk of electric shock, refer to the service manual for the equipment under test (when applicable) and follow the manufacturer's service and safety precautions particularly when voltages exceeding 30 VRMS or 50 VDC are present.

ERRATA

Inside Cover:

>Change manual part number, if necessary to agree with correct part number (10529-90005) on outside rear cover.

Page 2, Accessories Available List:

>Change 10529A (Option U2) to K01-10541B#.

Page 3:

>Change the Supply Voltage specification from 5 volts $\pm 10\%$ to 5 volts $\pm 5\%$.
>Change the Weight specification from Net, 2 lbs, 6 oz (1.14kg) to 2 lbs, 8 oz (1.14kg); and shipping from 2 lbs, 6 oz (1.65 kg) to 3 lbs (1.35 kg).

Page 13, paragraphs 4-20, and 4-21:

>Change all references of U1 to U2; and U2 to U1.

Page 37, Table 6-1, A3 (10529-60004) Replaceable Parts:

>Change reference designator U1 to U2; and U2 to U1.

Page 39, Paragraph 7-5, Option 002:

>Add "These boards are referenced to the following IC's:

7400 Quad 2-input NAND	7420 Dual 4-input NAND
7402 Quad 2-input NOR	7430 8-input NAND
7404 Hex inverter	7440 Dual 4-input NAND buffer
7408 Quad 2-input AND	7451 Dual 2-wide, 2-input AND-OR-INVERT
7410 Triple 3-input NAND	

ERRATA (cont'd)

Page 39, Paragraph 7-5, Option 002 (cont'd):

7454 4-wide, 2-input AND-OR-INVERT	7483 4-bit binary full adder
7473 Dual J-K master-slave flip-flop	7486 Quad 2-input exclusive-OR
7474 Dual D flip-flop	7490 Decade counter
7475 Quad bistable D latch	7493 4-bit binary counter
7476 Dual J-K flip-flop with preset and clear	74121 Monostable vibrator
	9601 Monostable multivibrator

Page 48, Figure 8-5, Self-Test Card Component

- >Change designation on resistor between C2 and Q3 from R11 to R5.
- >Change designator U1 to U2; and U2 to U1.

Page 50, Table of Active Elements:

- >Change A3U2 to 1820-0075.
- >Change A3U1 to 1820-0054.

MANUAL CHANGES MODEL 10529A (10529-90005) Page 3

CHANGE 1

Page 1, Paragraph 1-7:

- >Add the following to Equipment supplied:
10529-60014 SOCKET CARD:PROGRAMMABLE
10529-90007 MANUAL:OPERATING AND SERVICE SUPPLEMENT.

Page 38, Table 6-1, Replaceable Parts:

- >Add 10529-60014 SOCKET CARD:PROGRAMMABLE.
- >Add 10529-90007 MANUAL:OPERATING AND SERVICE SUPPLEMENT.

CHANGE 2

Page 17, Figure 4-2. Comparator Logic Channel Schematic:

- >Change 10K resistor in input circuit from 10K to 47K.

Page 21, Table 5-1. Assembly Designations:

- >Change HP Part No. 10529-60003 to 10529-60015.

Page 32, Table 6-1. Replaceable Parts:

- >Change A1 part number from 10529-60003 to 10529-60015 in "HP Part No." and "Mfr Part Number" columns.

Page 35 and 36, Table 6-1. Replaceable Parts:

- >Change A2R1, R3, R5, R7, R9, R11, R13, R15, R18-22, R24, R26, and R28 Part Numbers in HP and Mfr Part Number columns from 0698-5426 to 0698-6294 and resistor values from 10K to 47K ohm in "Description" column.

MANUAL, CHANGES MODEL 10529A (10529-90005) Page 4

CHANGE 2 (cont.)

Page 37, Table 6-1. "Miscellaneous Parts":

- >Change 10529-00002 to 10529-00003 in HP and Mfr Part Number columns.
- >Change 10529-20003 (A1 Blank Board) to 10529-20016 in HP and Mfr Part Number columns.

Page 50, A1 Schematic Diagram Tables:

- >Change "DS1-16" for A1 in "Reference Designations" table to DS1-17.
- >Change DS1 for A1 in second "TABLE" to DS1-17 ; HP Part No. to 1990-0416.

Page 51, Figure 8-6, A1 Schematic Diagram:

- >Change 10529-60003 for A1 DISPLAY ASSEMBLY to 10529-60015 (Series 1444).
- >Change A2R1, R5, R7, R3, R9, R11, R13, R15, R18, R20, R21, R22, R24, R26, and R28 from 10K to 47K ohms.
- >Add "(Series 1444)" after part number for A2 MAIN BOARD.

For instruments with serial numbers 1444A7440 and above, make the following changes:

Page 37, Table 6-1. Replaceable Parts:

- >Change A3R3 from 200 ohms to 51 ohms, new HP Part Number is 0683-5105.

Page 51, Figure 8-7. A3 Schematic Diagram:

- >Change A3R3 value from 200 ohms to 51 ohms.
- >Change A3 series number to 1444.

MANUAL CHANGES MODEL 10529A (10529-90005) Page 5

CHANGE 3

Page 32, Table 6-1, A1 Replaceable Parts:

>Add "(SERIES 1940)" to A1 "Description".

>Change AIDS1 through AIDS17 from part number 1990-0416 to 1990-0547 in HP and Mfr Part Number columns.

Page 51, Figure 8-6, A1 Schematic Diagram:

>Change A1 series number from 1444 to 1940.

Page 50, Table of Active Elements:

>Change AIDS1 through AIDS17 part number from 1990-0416 to 1990-0547.

CHANGE 4

Page 38, Table 6-1. Replaceable Parts:

>Change, under Description, Spring part number to 10528-20018, and Qty to 2.

#CHANGE 5

In the 10529A OPERATING AND SERVICE MANUAL SUPPLEMENT:

Page 1, DESCRIPTION, first sentence:

>Change Programmable Socket Card part number to 10529-60017.

Page 6, Table 1. Replaceable Parts:

>Change SOCKET-TEST HP Part No. to 1200-0975.

MANUAL CHANGES MODEL 10529A (10529-90005) Page 6

#CHANGE 5 (cont'd)

Page 7, Figure 2. 10529A Component Locator and Schematic Diagram:

>Change PROGRAMMABLE SOCKET part number to 10529-60017.

>Change SERIES to 2204.

Page 37, Table 6-1. A3 (10529-60004) Replaceable Parts:

>Change the HP Part Number for Q1 from 1855-0010 to 1855-0479.